

97050805
Rev. 03
2017.03



Contents

1. GENERAL WARNINGS	4
1.1. SYMBOLS.....	4
1.2. INTENDED USE	5
1.2.1. CLASSIFICATION AND REFERENCE STANDARDS	5
1.2.2. ENVIRONMENTAL CONDITIONS.....	5
1.2.2.1. TRANSPORT AND PACKAGING CONDITIONS	5
1.2.3. WARRANTY.....	5
1.2.4. DISPOSING THE EQUIPMENT WHEN NO LONGER USED	6
1.3. SAFETY WARNINGS.....	6
1.4. CLEANING AND DISINFECTION.....	8
2. DESCRIPTION OF THE EQUIPMENT	9
2.1. IDENTIFICATION PLATES	9
2.2. DENTAL UNITS	9
2.3. DENTAL CHAIR.....	10
2.3.1. 3.0 FL DENTAL CHAIR	10
2.3.2. 3.0 ML DENTAL CHAIR	10
3. TURNING ON THE OPERATING UNIT	11
4. DENTAL CHAIR OPERATION	11
4.1. SAFETY DEVICES.....	12
4.2. EMERGENCY DEVICES.....	12
4.3. ADJUSTABLE HEADREST.....	13
4.4. MOVABLE ARMRESTS (OPTIONAL)	13
5. DENTIST'S BOARD OPERATION	14
5.1. DENTIST'S CONTROL CONSOLE	17
5.1.1. USER'S INTERFACE	19
5.1.1.1. OPERATOR SELECTION	20
5.1.1.2. MAIN SETTINGS	20
5.1.1.2.1. BIOSTER DISINFECTION CYCLE SETTING	21
5.1.1.2.2. SETTING THE FLUSCHING CYCLE	22
5.1.1.2.3. W.H.E. SYSTEM TANK EMPTYING	22
5.1.1.2.4. WATER-TO-BOWL SETTING.....	23
5.1.1.2.5. WATER-TO-CUP SETTING.....	23
5.1.1.2.6. BOWL AUTOMATIC MOVEMENT SETTING.....	24
5.1.1.2.7. FOOT CONTROL SETTING	24
5.1.1.2.8. OPERATING LIGHT SETTING	25
5.1.1.2.9. OTHER SETTINGS.....	25
5.1.1.2.10. DATA AND TIME ADJUSTMENT.....	26
5.1.1.2.11. STOPWATCH.....	26
5.1.1.2.14. LANGUAGE SELECTION	28
5.1.1.2.15. USB SETUP	28
5.1.1.2.16. IMAGE MANAGEMENT.....	29
5.1.1.2.16.1. IMAGE MANAGEMENT THROUGH iRYS	30
5.1.1.2.17. APEX LOCATOR SETTING.....	32
5.1.2. SETTING THE DENTAL CHAIR "AUTOMATIC RETURN" AND "RINSE POSITION"	32
5.1.3. DENTAL CHAIR POSITION PROGRAMMING	33
5.1.4. EMERGENCY BUTTON.....	33
5.1.5. TOUCH-SCREEN LOCK BUTTON.....	33
5.1.6. BED POSITION RECALL BUTTON.....	34
5.2. FOOT CONTROL.....	34
5.2.1. "MULTIFUNCTION" FOOT CONTROL	34
5.2.2. "PUSH-PEDAL" FOOT CONTROL	36
5.2.3. "POWER PEDAL" FOOT CONTROL.....	38
5.2.4. WIRELESS FOOT CONTROL.....	39
5.3. SYRINGE.....	41
5.4. TURBINE	43
5.5. ELECTRIC MICROMOTOR	46
5.5.1. RESTORATIVE OPERATING MODE	50
5.5.2. ENDODONTIC OPERATING MODE	50
5.5.2.1. ROOT CANAL DRILL CUSTOMIZATION MENU.....	52
5.5.3. IMPLANT OPERATING MODE	53
5.5.4. REDUCTION RATIO SETTING MENU.....	54
5.5.5. RECIPROCATING OPERATING MODE	55
5.6. SCALER.....	56
5.7. T LED CURING LIGHT.....	59
5.8. C-U2 DENTAL CAMERA.....	63
5.9. ZEN-Xi INTEGRATED SENSOR	68
5.10. PERISTALTIC PUMP	69
5.11. ELECTRONIC APEX LOCATOR.....	71

6. ASSISTANT'S BOARD OPERATION.....	73
6.1. ASSISTANT'S BOARD CONSOLE	73
6.2. SYRINGE.....	74
6.3. T LED CURING LIGHT.....	74
6.4. C-U2 DENTAL CAMERA.....	74
6.5. SUCTION TUBES	75
6.6. TRAY HOLDER.....	76
7. WATER UNIT OPERATION.....	76
7.1. FILL CUP AND BOWL	76
7.2. S.H.S. SYSTEM.....	77
7.3. W.H.E. SYSTEM (WATER HYGIENIZATION EQUIPMENT).....	79
7.4. BIOSTER DISINFECTION AUTOMATIC SYSTEM	81
7.5. AUTOMATIC INSTRUMENT FLUSHING CYCLE.....	83
7.6. A.C.V.S. SYSTEM (AUTOMATIC CLEANING VACUUM SYSTEM)	84
7.7. OPENING/CLOSING THE WATER UNIT SIDE COVER	85
8. ACCESSORIES.....	86
8.1. OPERATING LAMP	86
8.2. MONITOR ON LAMP POLE	86
8.3. NEGATOSCOPE FOR PANORAMIC X-RAYS.....	86
8.4. AIR/WATER/230V QUICK-COUPLINGS	87
8.5. AUXILIARY TRAY HOLDER	87
9. MAINTENANCE.....	88
9.1. MAINTAINING THE INSTRUMENTS	88
9.2. DRAINING CONDENSATE	88
9.3. CLEANING THE SURGICAL SUCTION FILTER.....	89
9.4. SURGICAL SUCTION.....	89
9.5. CATTANI SURGICAL SEPARATOR	90
9.6. CLEANING THE TURBINE RETURN AIR FILTER.....	91
9.7. METASYS AMALGAM SEPARATOR.....	91
9.8. DÜRR AMALGAM SEPARATOR	91
9.9. DENTAL CHAIR.....	91
10. WARNING MESSAGES.....	92
11. TECHNICAL DATA.....	94
11.1. DIMENSIONAL CHARACTERISTICS	95
12. DENTAL UNIT OPERATING UNIT MAINTENANCE PLAN.....	99

1. GENERAL WARNINGS

• These instructions explain how to correctly use the following dental units:

L9 CONTINENTAL, L9 SIDE DELIVERY.

Please carefully read this manual before using the device.

- The dental units described in this manual are manufactured by CEFLA s.c. - via Selice Prov.le 23/A - 40026 Imola (BO) Italy, a manufacturer complying with the European Directive on devices.
- These instructions describe all the versions of the dental units with the maximum possible accessories, therefore not all the paragraphs are applicable to the unit you have purchased.
- It is forbidden to reproduce, store and transmit this publication by any means (electronically, mechanically, by photocopying, translating or in other ways) without a written authorisation issued by CEFLA s.c..
- The information, technical specifications and illustrations contained in this publication are not binding. CEFLA s.c. reserves the right to introduce modifications and technical improvements without having to modify these instructions.
- The manufacturer has a company policy of continual development. Although every effort is made to keep technical documentation up-to-date at all times some of the instructions, specifications and figures given in this manual may slightly differ from the purchased product. The manufacturer reserves the right to make changes without prior notice.
- The original text is in Italian; translation from the original in Italian.
- This equipment is equipped with a device that prevents liquid back flow.
- The manufacturer's website contains a list of authorised agents of the various countries.

1.1. SYMBOLS

Note the meaning of the following symbols and expressions:

	Type of protection against direct and indirect contact: Class I.		Equipment in compliance with essential requirements of directive 93/42/EU and subsequent changes (Class IIa Medical Device). Notified body: IMQ spa.
	Type of protection against direct and indirect contact: Type B.	0051	
	WARNING! Failure to observe may result in equipment damage or injury to the user and/or patient.		Accessory in compliance with essential requirements of directive 93/42/EU and subsequent changes (Class I Medical Device).
	"Consult the instruction manual" It means that it is advisable to consult the instruction manual before using that part of the device.		Disposal symbol in accordance with Directive 2012/19/EU
	NOTE: Identifies information that is especially important for the user and/or the assistant.		"Warning biological hazard". It provides information about possible risks of contamination deriving from contact with fluids, storage of infected biological waste.
	Protective ground contact.		Manufacturer.
	Alternating current.		Month and year of construction.
	Part that can be sterilised in a steam autoclave up to 135° C.	SN	Device serial number.
	ON / OFF button.		DVGW mark (Quality assurance kitemark regarding supply of drinking water).
	"Refer to the instruction manual" Means that for reasons of safety you need to consult the instruction manual before using the equipment.		Product/equipment identification code.
	Off (a part of the unit).		Pushing prohibited.
	On (a part of the unit).		Foot crushing hazard.
	Equipment On.		Equipment equivalent to Class 2 light source.
	Equipment OFF.		Hand crushing hazard.
			Ukrainian national symbol of conformity.

1.2. INTENDED USE

- The dental units described in this manual are Medical Devices intended for dental treatment.
- The dentist's board may hold up to 6 instruments.
- The assistant's board can hold 2 suction tubes and 3 instruments.
- This equipment must be used only by adequately trained personnel (dentists and paramedics).
- The device is intended for non-continuous operation with intermittent loads (see the operating times of the individual parts in the dedicated sections).
- The device is classified as pollution degree 2.
- Overvoltage class: II.

1.2.1. CLASSIFICATION AND REFERENCE STANDARDS

MEDICAL DEVICES classification

Classification of the dental unit in accordance with the indications given in annex IX of directive 93/42/EC as amended:

Class IIa.

ELECTRICAL MEDICAL EQUIPMENT classification

Classification of the dental unit in accordance with standard EN 60601-1 on safety of medical equipment: **Class I - Type B.**

- Reference standards: the dental units described in this manual are designed and manufactured in compliance with IEC60601-1 3rd Ed. - 2007, IEC 60601-1-6 3rd Ed. - 2010, IEC 62366 1st Ed. - 2007, IEC 80601-2-60 1st Ed. - 2012, IEC 60601-1-2 3rd Ed., ISO 6875 3rd Ed. - 2011, ISO 7494-1 2nd Ed. - 2011 and EN 1717 (type AA and AB) standards as far as water mains safety devices are concerned.

Classification of RADIO DEVICES AND COMMUNICATION TERMINALS (only when the WIRELESS foot control is present)

Equipment classification according to Directive 99/05/EC Art.12: **Class I.**

1.2.2. ENVIRONMENTAL CONDITIONS

The equipment is to be installed in rooms that satisfy the following requirements:

- temperature between 10 and 40 °C;
- relative humidity between 30 and 75%;
- atmospheric pressure ranging from 700 to 1060 hPa;
- altitude \leq 3000 m;
- air pressure entering equipment ranging from 6 to 8 bar;
- water hardness at the equipment inlet must not be above 25 °f (French degrees) or 14 °d (German degrees) for untreated drinking water. For water with a higher hardness degree, it is recommended to soften water until it reaches a hardness degree between 15 and 25 °f (French degrees) or between 8.4 and 14 °d (German degrees);
- water pressure entering equipment ranging from 3 to 5 bar;
- water temperature entering equipment not higher than 25 °C.

1.2.2.1. TRANSPORT AND PACKAGING CONDITIONS

- Temperature between -10 and 70°C;
- Relative humidity between 10 and 90%;
- Atmospheric pressure: from 500 to 1060hPa.

1.2.3. WARRANTY

CEFLA s.c. stands behind its products warranting safety, reliability and performance.

The warranty is valid only under the following terms:

- Conditions given on the warranty certificate are observed.
- Yearly scheduled maintenance is performed.
- The equipment is used only as instructed in this manual.
- The electrical wiring in the room in which the equipment is installed must conform to IEC 60364-7-710 (standards for electrical wiring in medical and dental offices).
- A 3x1.5 mm² line protected by a bi-polar cut-out that conforms to applicable standards (10 A, 250 V, distance between contacts at least 3 mm) must be used to feed the equipment.



WARNING:

The colour of the three wires (POWER, NEUTRAL and EARTH) should satisfy the requirements of current standards.

- Installation, repairs and, in general, any other operation requiring the casing to be opened are to be performed exclusively by personnel authorised by ANTHOS.

1.2.4. DISPOSING THE EQUIPMENT WHEN NO LONGER USED

In compliance with Directives 2011/65/EU and 2012/19/EU regarding restriction of the use of certain hazardous substances in electrical and electronic equipment along with waste electrical and electronic equipment, it is forbidden to dispose of this equipment in the municipal waste stream as unsorted municipal waste.

When new equipment that is similar is purchased, the old equipment must be given to the dealer for disposal. As regards reuse, recycling and other forms of recovery of waste electrical and electronic equipment, the manufacturer carries out the functions defined by current local laws. A high level of separate collection of waste electrical and electronic equipment is indispensable to efficiently recycle, treat and dispose of the equipment. Recycling and treatment operations should comply with minimum standards to assure human health and high environmental protection as well as favour recycling of the materials included in the equipment. The symbol indicating separate collection for electrical and electronic equipment consists of the crossed out bin marked on the equipment.



WARNING:

Illegal waste clearance and disposal shall be punished as established by laws and regulations currently in force in the individual countries.

1.3. SAFETY WARNINGS



WARNING:

- **All devices are permanently installed.**

Depending on the type of dental chair the unit comes with, refer to the installation SCHEMATICS in paragraph "Technical Specifications". The CEFLA s.c. shall not be held liable for any personal injury or property damage arising from failure to heed the following clause.

- **Floor conditions.**

The floor (continuous) should meet the load-bearing capacity set forth by DIN 1055, sheet 3.

The weight of the dental unit including a 190 kg patient is about 350 kg.

For further details on anchoring conditions, refer to the Installation Manual.

The positions of delivery and drain line connections comply with standard UNI EN ISO 11144.

In case of floor installation without load reduction plate, floor characteristics must ensure a breaking strength of the anchor bolt not less than 1200 daN each (considering R_c concrete strength 20 MPa).

In case of floor installation without load reduction plate, floor characteristics must ensure a strength of the anchor bolt not less than 260 daN.

- This device may not be modified in any way without the authorisation of the manufacturer.

If the device is modified, appropriate examinations and tests need to be conducted in order to ensure continued safe use.

CEFLA s.c. shall not be held liable for any personal injury or property damage arising from failure to heed the following clause.

- **Dental chair.**

Dental chair maximum loading capacity is 190 Kg. Do not exceed this value.

- **Tray holder bearing surface.**

The maximum loading capacity must never be exceeded:

- tray holder module attached to the dentist's board, maximum allowable load 2 Kg, evenly distributed.
- tray holder module attached to the assistant's board, maximum allowable load 1 Kg, evenly distributed.
- auxiliary tray holder module, maximum allowable load on tray 3.5 Kg (without negatoscope) or 2.5 Kg (with negatoscope).

- **Connections to external instruments.**

The equipment can be hooked up only to other instruments that bear the CE mark.

- **Electromagnetic interferences.**

Use of electrical equipment that does not comply with standard IEC 60601-1 3rd Ed. - 2007 in the office or nearby may cause electromagnetic or other types of interferences resulting in dental unit malfunctions.

In these cases **it is recommended** to shut off the dental unit power before using this equipment.

- **Replacing the drills.**

Operate the turbine release and contra-angle devices only once the drill has come to a complete stop. Failure to do so, will result in damaging the locking system and drills could be released and cause injury. Exclusively use high-quality drills with a connection having a calibrated diameter. To check the conditions of the locking system, make sure the drill is firmly secured to the instrument every day before starting work. Locking system defects caused by misuse can be easily identified and are not covered by the warranty.

The drills and various instruments attached to the handpieces must comply with Biocompatibility Standard ISO 10993.

- **Patients with pace makers and/or hearing aids.**

When treating patients with pace makers and/or hearing aids, take into consideration the effects the instruments may have on pace makers and/or hearing aids. Carefully read technical-scientific information available on this subject.

- **Implants.**

If the dental unit is used for implant operations using separate equipment designed for this purpose, **you are recommended** to shut the power off the dental chair to avoid unwanted movements resulting from faults and/or accidental start-ups of the controls.

- Do not forget to turn off the office water supply and master switch of the equipment before leaving the surgery.

- The equipment is not protected against liquid penetration (IPX 0).

- The equipment is not suitable for use in the presence of a mixture of flammable anaesthetic gas with oxygen or nitrous oxide.

- This equipment must be stored properly so that it is kept in top working order at all times. The manufacturer shall not be held liable for misuse, carelessness or improper use of the equipment.

- The equipment may only be used by authorised and adequately trained staff (dentists and paramedics).

- The user must be present at all times when the equipment is turned on or ready for start-up. In particular, never leave the equipment unattended in the presence of children/ mentally disabled or other unauthorised personnel in general.

Any accompanying persons must keep out of the operating area and in any case under the responsibility of the operator. The operating area refers to the space around the dental unit plus 1.5 meters.

- **Quality of the water delivered by the dental unit.**

The user is responsible for the quality of the water delivered by the dental unit and must adopt measures to maintain the water quality.

To ensure that delivered water is kept to quality standards, CEFLA s.c. recommends equipping the dental unit with an internal or external disinfection system.

The dental unit, once installed, is exposed to possible contaminants coming from the water mains. So, to effectively overcome this problem, it is advisable to install the dental unit only when its use will be daily and to perform the disinfecting procedures starting from the day in which it is installed by following the instructions set forth in the relevant sections.

If the dental unit is equipped with the air separation device from water mains (EN 1717), make sure that the expected continuous supply of disinfectant is also carried out by ensuring that the relevant tank contains a suitable quantity of disinfectant (see relevant paragraph).



NOTE:

contact your local dealer or Dentists Association for more detailed information about national laws and requirements.

• **Applied parts.**

The parts of the equipment that come into contact with the patient while carrying out its functions correctly during standard use are: dental chair upholstery, armrest, curing light fibre optics, syringe terminal, disposable camera protection, scaler bits, handpiece drills, suction tube terminals.

Non applied parts that may come into contact with the patient are: dental chair armrest support, dental chair lower casing, patient-side water unit casing, water-to cup-spout, bowl, suction tubes, handpiece body.



WARNING:

Dental chair movement.

Make sure that the patient is ready to collaborate: ask him/her to keep his/her hands and feet close to the body, avoiding incorrect postures.

Check that the patient is sitting properly when moving the dental chair (see figure).

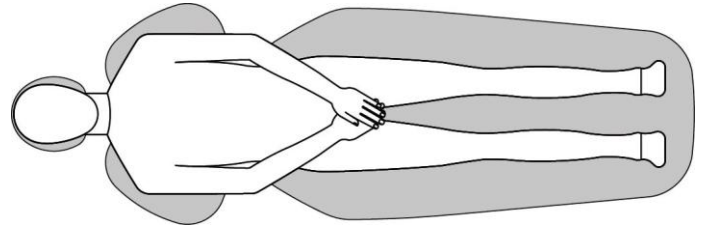

1.4. CLEANING AND DISINFECTION

Cleaning is the first step of any disinfecting process.

Physically scrubbing with detergents and surface-active substances and rinsing with water removes a considerable amount of micro-organisms. If a surface is not clean first, the disinfecting process cannot be successful.

If a surface cannot be adequately cleaned, it should be protected with barriers.

The outer parts of the equipment must be cleaned and disinfected using a product for hospital use with indications for HIV, HBV and tuberculocide (medium-level disinfectant) specifically for small surfaces.

The various drugs and chemical products used in dental surgeries may damage the painted surfaces and the plastic parts. Researches and tests performed show that the surfaces cannot be fully protected against the harsh action of all products available on the market. We therefore recommend protecting with barriers whenever possible.

The harsh actions of chemical products also depend on the amount of time they are left on the surfaces.

It is therefore important not to leave the product on the surfaces longer than the time specified by the manufacturer.

It is recommended to use the specific medium-level disinfectant, STER 1 PLUS (CEFLA s.c.), which is compatible with:

- Coated surfaces and plastic parts.
- Upholstery.



WARNING:

The MEMORY FOAM upholstery will stain when splashed with mordant acid. Immediately rinse with plenty of water if acid splatters on the upholstery.

- Uncoated metal surfaces.

If you do not use STER 1 PLUS, it is recommended to use products that contain at maximum:

- Ethanol. Concentration: maximum 30 g per 100 g of disinfectant.
- 1-Propanol (n-propanol, propyl alcohol, n-propyl alcohol). Concentration: maximum 20 g per 100 g of disinfectant.
- Combination of ethanol and propanol. Concentration: the combination of the two should be maximum 40 g per 100 g of disinfectant.



WARNING:

- Do not use products containing isopropyl alcohol (2-propanol, iso-propanol).
- Do not use products that contain sodium hypochlorite (bleach).
- Do not use cleaners that contain phenols.
- Do not spray the selected products directly on the surfaces.
- All products must be used as directed by the manufacturer.
- Do not mix the STER 1 PLUS disinfectant with other products.



WARNING:

The products suggested are compatible with the materials of the equipment, however damages may occur to surfaces and materials resulting from the use of different products, even if not included in the above list of excluded products.

Cleaning and disinfecting instructions.

Clean and disinfect with disposable non-abrasive paper (avoid using recycled paper) or sterile gauze.

Do not use sponges or, in any case, any material that can be reused.



WARNING:

- Turn off the dental unit prior to cleaning and disinfecting the external parts.
- All materials used to clean and disinfect must be thrown away.

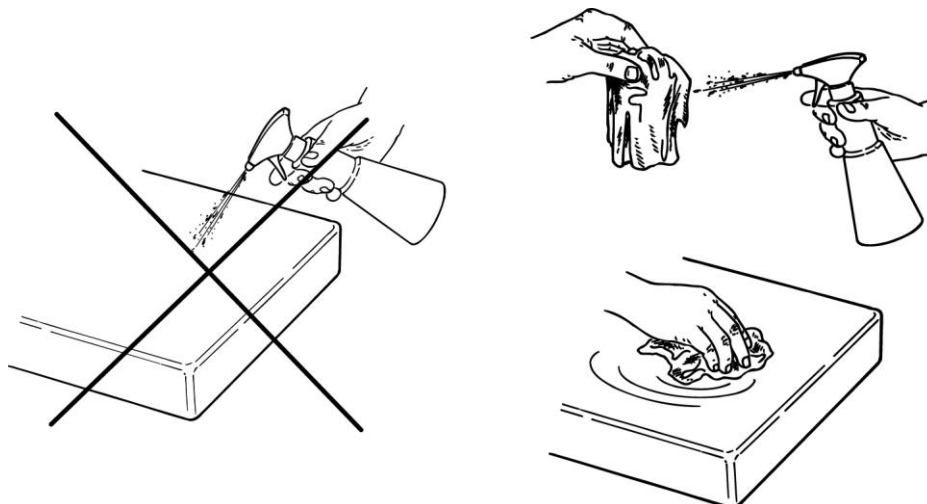

2. DESCRIPTION OF THE EQUIPMENT

2.1. IDENTIFICATION PLATES

Plate is positioned on water unit, close to main switch.

Data given on plate:

- Manufacturer's name.
- Name of equipment.
- Rated voltage.
- Type of current.
- Nominal frequency.
- Maximum absorbed power.
- Serial number.
- Month and year of manufacture.

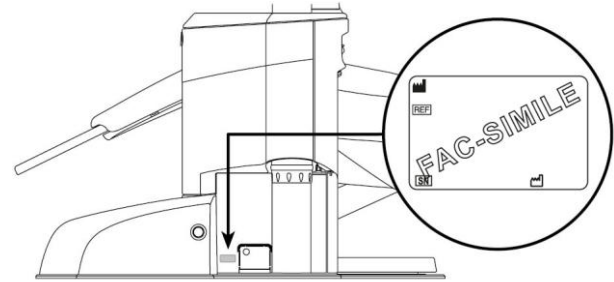

2.2. DENTAL UNITS

Models:

Model L9 CONTINENTAL.

Description of the different parts:

- a Water unit.
- b Adjustable arm.
- c Dentist's board.
- d Dentist's control console (reversible optional).
- e Tray holder board.
- f Assistant's board.
- g Assistant's board control console.
- i Multifunction foot control.
- l Water-to-cup spout.
- m Bowl.
- n Self-balancing arm.
- q Tray holder board on assistant's board (optional).
- z Dental chair.

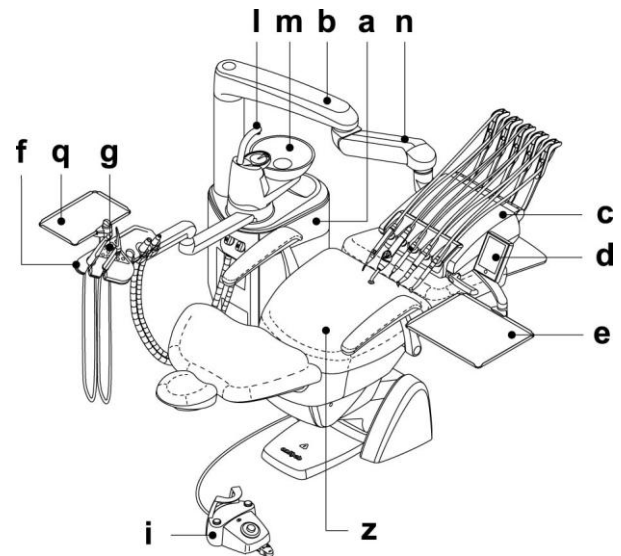

Model L9 SIDE DELIVERY.

Description of the different parts:

- a Water unit.
- c Dentist's board.
- d Dentist's control console.
- f Assistant's board.
- g Assistant's board control console.
- i Multifunction foot control.
- l Water-to-cup spout.
- m Bowl.
- p Height-adjustable column.
- q Tray holder board on assistant's board (optional).
- r Negatoscope for panoramic X-rays (optional).
- s "Professional" auxiliary board (optional).
- z Dental chair.

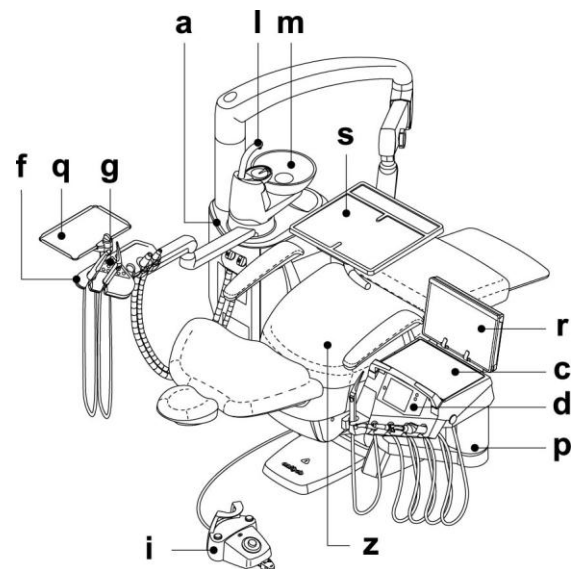

2.3. DENTAL CHAIR

The dental chair comes in 2 types:

(1) Dental chair A 3.0 FL

Dental chair with wide or narrow backrest and equipped with full seat

(2) Dental chair A 3.0 ML

Dental chair with wide or narrow backrest and equipped with split seat, motor-driven leg rest and retractable foot rest.

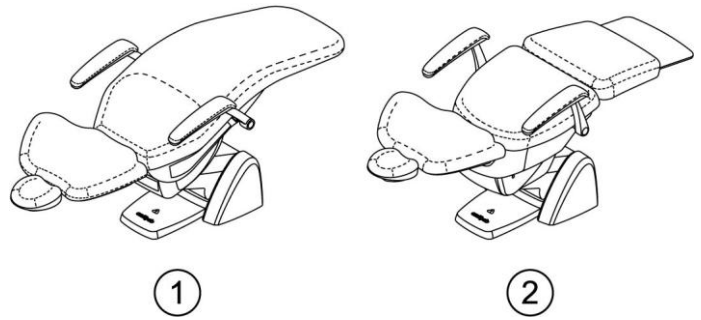

2.3.1. 3.0 FL DENTAL CHAIR

Description of the parts.

- a Headrest.
- b Backrest.
- c Fixed armrest.
- d Removable armrest (optional).
- e Safety foot board.

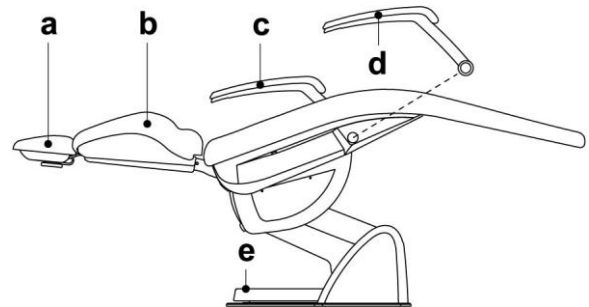

Operating time.

The operating and rest times are as follows:

work 25 sec. - rest 10 min.

Maximum permitted load.

- Maximum permitted load on the dental chair: 190 Kg.
- Maximum permitted load on headrest: 30 Kg.
- Maximum permitted load on armrest: 68 Kg.



WARNING:
Do not exceed these values.

Warnings for use



WARNING:
FOOT CRUSHING HAZARD
Pay attention to the patient and the staff during dental chair rotation and/or lowering.

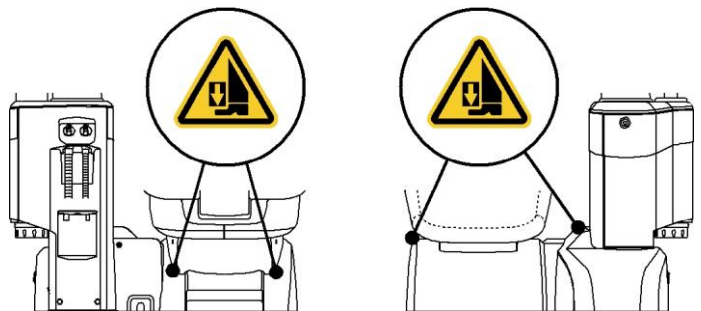

2.3.2. 3.0 ML DENTAL CHAIR

Description of the parts.

- a Headrest.
- b Backrest.
- c Fixed armrest.
- d Removable armrest (optional).
- e Safety foot board.
- f Motor-driven leg rest.
- g Retractable foot rest.

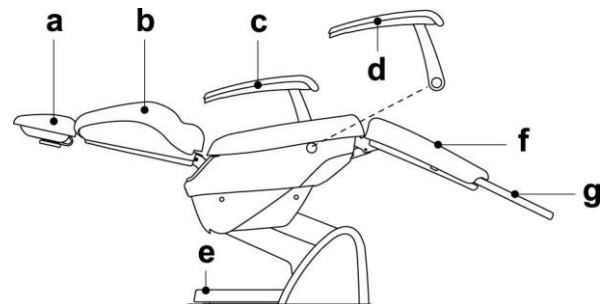

Operating time.

The operating and rest times are as follows:

work 25 sec. - rest 10 min.

Maximum permitted load.

- Maximum permitted load on the dental chair: 190 Kg.
- Maximum permitted load on headrest: 30 Kg.
- Maximum permitted load on armrest: 68 Kg.



WARNING:
Do not exceed these values.

Warnings for use



WARNING:
FOOT CRUSHING HAZARD
Pay attention to the patient and the staff during dental chair rotation and/or lowering.

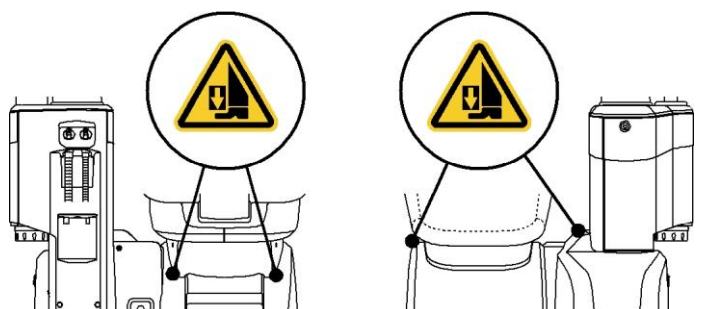

3. TURNING ON THE OPERATING UNIT

Press the main switch (**f1**) positioned on connection box casing and check the following on the control console:

- **Display (g) is off:**
 - equipment is off
 - pneumatic system is disconnected
 - water system is disconnected.
- **Display (g) is on:**
 - equipment is on
 - pneumatic system on
 - water system is connected.



WARNING:
Main switch must be pressed with your hands.

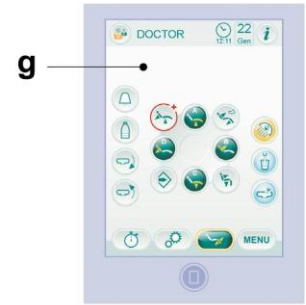
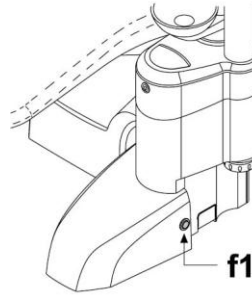

4. DENTAL CHAIR OPERATION

The dental chair can be moved as follows:

Dental chair A 3.0 FL

- Chair seat up/down.
- Backrest rotation with inclination of the chair seat (compensated Trendelenburg).

Dental chair A 3.0 ML

- Chair seat up/down.
- Backrest rotation.
- Leg support rotation.
- Footrest sliding.

The dental chair can be operated from the following units:

- Dentist's board (**a**) (see par. 5.).
- Multifunction foot control (**b**) (see par. 5.2.).
- Assistant's board (**c**) (see par. 6.).

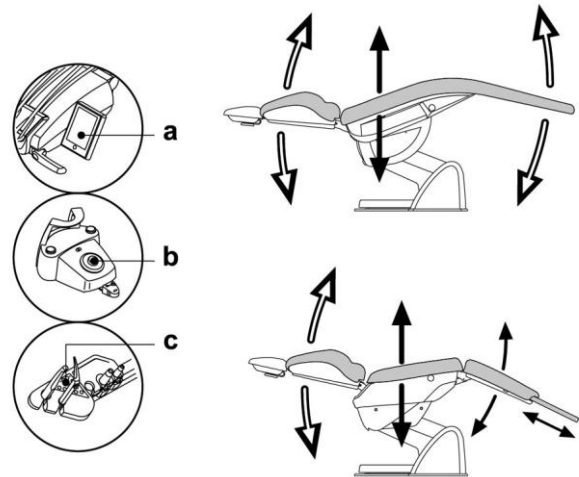

Dental chair movement lock.

With the instruments in rest position, dental chair movements can be disabled (see paragraph 5.1.1.2.5).

Movement disabling is highlighted on the console display by the special icon (**A**).



4.1. SAFETY DEVICES

- The floor board is equipped with a device (l) that immediately stops the dental chair down movement in the presence of an obstacle and automatically moves the seat up to free the obstacle.
- The backrest is equipped with a device (m) that immediately stops dental chair down movement in the presence of an obstacle and automatically moves the seat up to free the obstacle.
- With dental chair A 3.0 ML only: the backrest is equipped with a device (n) that immediately stops backrest down movement in the presence of an obstacle and automatically moves the backrest up to free the obstacle.
- With dental chair A 3.0 ML only: the leg rest is equipped with a device (o) that immediately stops down movement in the presence of an obstacle and then automatically moves the seat up to free the obstacle
- With dental chair A 3.0 ML only: the foot rest is equipped with a device (p) that immediately stops extraction in the presence of an obstacle and then automatically retracts it to free the obstacle.
- The bowl is equipped with a safety device (d) that stops all dental chair movements when the bowl is inside the interference area.

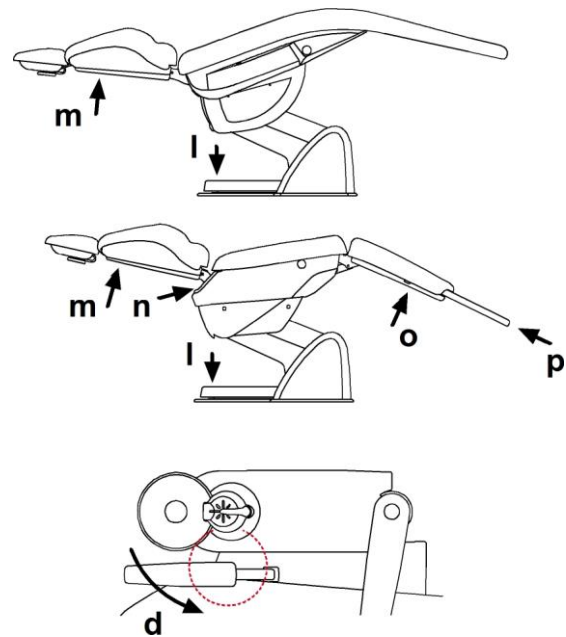

NOTE:

with motor-driven bowl, the safety device automatically moves the bowl out of the interference area with the dental chair.

- Dental chair movements:
 - with the instrument extracted NOT working: manual movements allowed, automatic movements inhibited, but if they are already in progress at the moment of extraction they are not interrupted;
 - with instrument extracted and working: all the chair movements are inhibited.

4.2. EMERGENCY DEVICES



WARNING:

Use the devices below when movement of the equipment needs to be stopped:

- **Dental chair control buttons (a) or (c).**
By pressing any of the dental chair control buttons all movements will be stopped.
- **Foot control (b).**
When the foot control is activated, all movements of the equipment are stopped.
- **Foot board (i).**
When the chair foot board is actuated, all movements of the equipment are blocked.

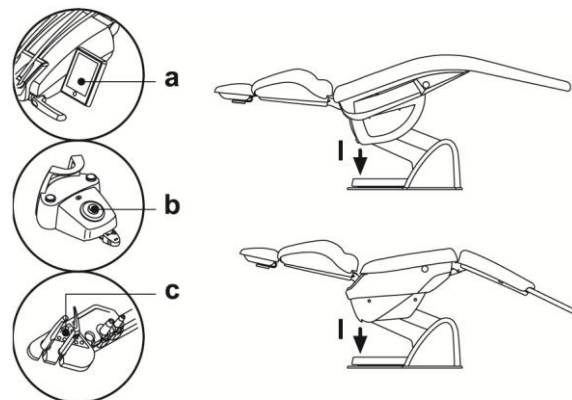

4.3. ADJUSTABLE HEADREST

The headrest may be of two types:

- (1) with manual cushion lock lever
- (2) with pneumatic cushion lock lever

Adjusting headrest height.

- with manual lock (1):

The head rest blade is positioned through a magnetic clutch. The operator should pull up and/or push down the headrest until it is in the desired position.
- with pneumatic lock (2):

Press and hold down the locking button (u) to position the headrest as desired. Once you have reached the desired position, release the button (u) to lock the headrest in place.

Adjusting the cushion.

- with manual lock (1):

Rotate the lock knob (k) anti-clockwise, position the cushion as desired and then re-tighten the lock knob.
- with pneumatic lock (2):

Press the lock button (u) and keep it pressed as you adjust the cushion as desired. Once the cushion is oriented as desired just release the button (u) to lock in place.

Proper positioning of the headrest.

-  **WARNING:**
For correct use of the headrest, position the patient's head as shown in the figure.

Warnings for use.

-  **WARNING:**
 - Maximum permitted load on headrest: 30 Kg.
 - Do not attempt to move headrest while patient is resting against it.
 - Do not attempt to modify the position of the cushion without first releasing the lock mechanism.
 - The pneumatic locking device is active only when the air circuit is pressurized and the dental unit is on.

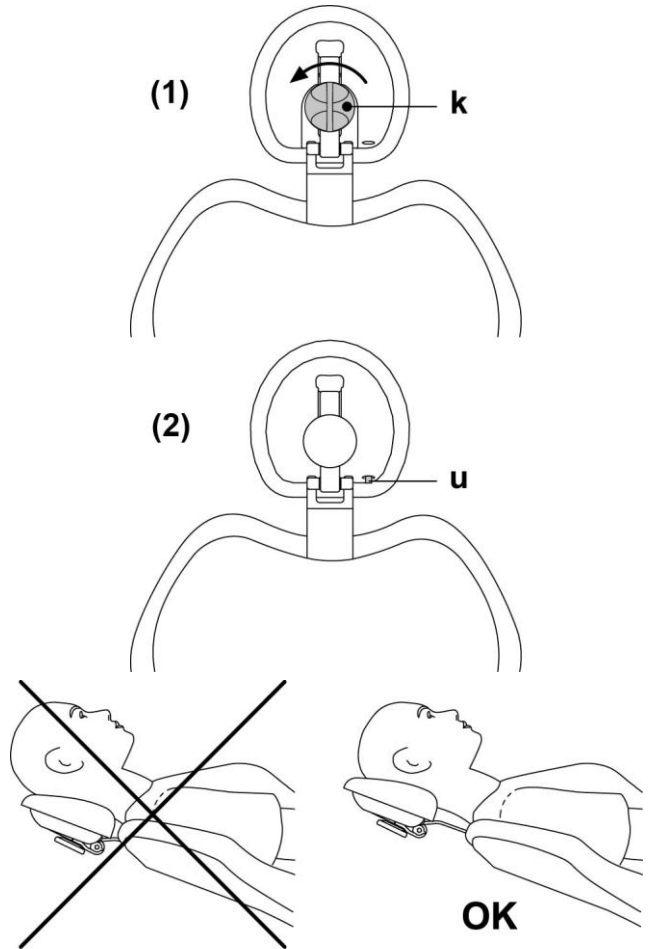

4.4. MOVABLE ARMRESTS (OPTIONAL)

Movable armrest overturning.

Turn movable armrest downwards so that the patient can easily get on and off the chair.

Movable armrest removal.

Move the armrest in vertical position and slide it out from seat.

-  **WARNING:**
Maximum load supported by armrest: 68 kg.

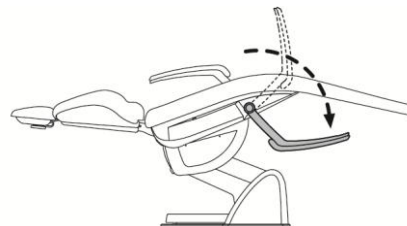

5. DENTIST'S BOARD OPERATION

Layout of instruments.

The positions of the instruments on the board are determined by the customer at the time of order.

Enabling the instruments.

- The syringe is always on (see paragraph 5.3.).
- The curing light is turned on by the relevant button, when the instrument is extracted (see paragraph 5.7.).
- Intraoral camera turns on when the instrument is extracted (see paragraph 5.8.).
- The ZEN-Xi integrated sensor is started by turning its support to the "ACTIVE" position (see paragraph 5.9 and ZEN-Xi instructions for use).
- Once picked up, all the instruments are operated with the foot control (see paragraph 5.2.).

Simultaneous use of the instruments.

An interlocking device ensures that the instruments are not used simultaneously.

The first extracted instrument is ready to be used while those extracted later are disabled by the interlocking device.

This interlocking device allows the drill to be changed in one instrument while another is used on the patient.

Positioning the dentist's board.

The dentist's board can move in all directions.

To adjust the height of the board and/or direct it horizontally, simply grasp the handle (**a**).



NOTE CONTINENTAL version:

to release pantograph arm pneumatic brake, grasp the handle with your thumb on point (**A**).



NOTE SIDE DELIVERY version:

to adjust height, press the special up/down buttons (see paragraph 5.1.).



WARNING:

Up/down operating times for SIDE DELIVERY board: continuous operation max. 2 min. - rest 18 min.

Instrument recall arm locking device (for CONTINENTAL boards, only).

If this device is provided, the instrument recall arm can be locked in the instrument extracted position.

Lock engages with a click at about 2/3 of the total arm travel.

To go back to the original condition, simply move the arm to the end of its travel (**B**).

Tray holder for CONTINENTAL board.

The tray holder (**f**) is made of stainless steel and can easily be removed from its support.



WARNING:

Maximum permitted load on the tray holder (**f**): 2 kg evenly distributed.

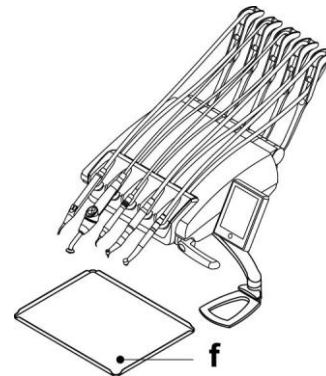
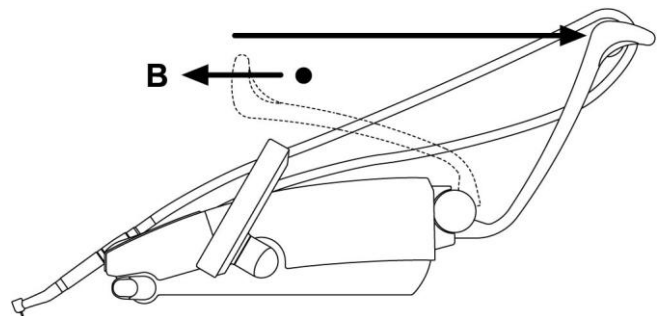
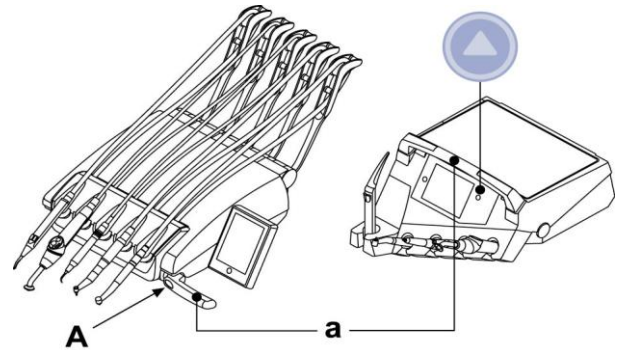

Console unit position reversal (with reversible console, only).

WARNING:
Before carrying out this operation, turn the dental unit off.
NEVER REMOVE THE CONSOLE FROM BOARD IF DENTAL UNIT IS ON.

To reverse console unit position on dentist's board, proceed as follows:

- Remove the console unit after having loosened the relevant fixing ring nut (**g**) by turning it counter clockwise.
 - Remove the click-on cap (**s**) protecting the quick coupling on the left-hand side, and insert it inside the one on the right-hand side.
 - Turn console unit supporting arm by 180°.
 - Fit the console unit inside the quick coupling on left-hand side.
- To identify the correct positioning of the console unit, push arm fully down inside support and, at the same time screw ring nut by approx. 1/3 of a turn until it locks in place, but without forcing it.

NOTE:
to avoid that dentist's board can escape on the other side, turn it by approx. 90° compared to its supporting arm position (see figure) before starting its positioning.

- Now dental unit can be turned on again.

WARNING:
During console cleaning operations, do not exert too much pressure on control pad to avoid putting stress on to the connection.

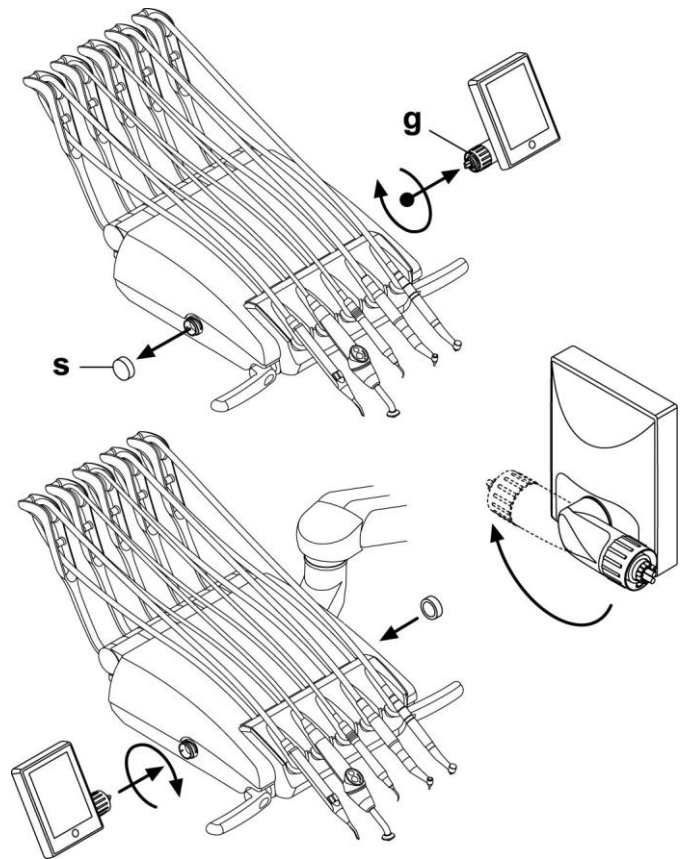

USB connector.

Dentist's board is equipped with a "host" USB port, with A type connector. Port can supply the connected peripheral, up to a max. of 500 mA.

To use USB connector, see paragraphs 5.1.1.2.15 and 5.1.1.2.16.

WARNING:

- Connector is not protected against liquid penetration.
- Do not insert metal objects other than a A type USB connector inside the connector.
- When unused, we recommend always covering the connector with the special rubber cap.

Supported devices:

- USB flash drives 2.0 or 3.0 with a storage capacity between 128 MB and 64 GB,
- USB 2.0 or 3.0 external hard disks, provided that they are separately powered,
- flash drives or hard disks formatted in FAT and FAT32 formats, normally available on the market,
- the devices formatted according to the NTFS standard are not compatible.

NOTE:
port features a current limiter avoiding the console to be damaged in case of accidental connection of faulty devices.

Cleaning the dentist's board.

Clean the dentist's board using a suitable product (see paragraph 1.4).

NOTE for CONTINENTAL version instrument boards:
*instrument holder (**x**) can be removed to make cleaning operations easier; to remove it, simply extract it from its seat as it is fixed with magnets.*
*The silicone instrument holder (**u**) can also be sterilised in an autoclave up to 135°C.*

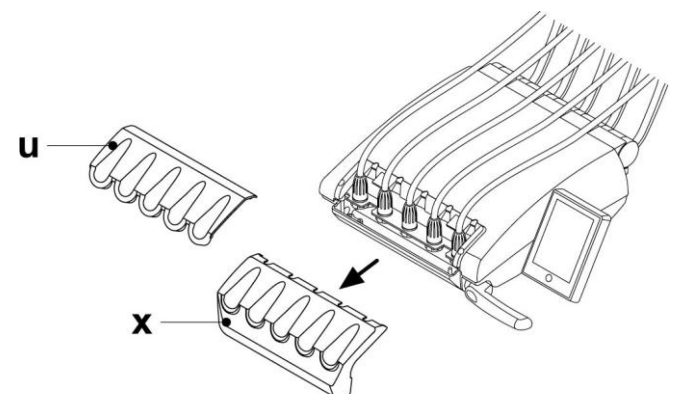
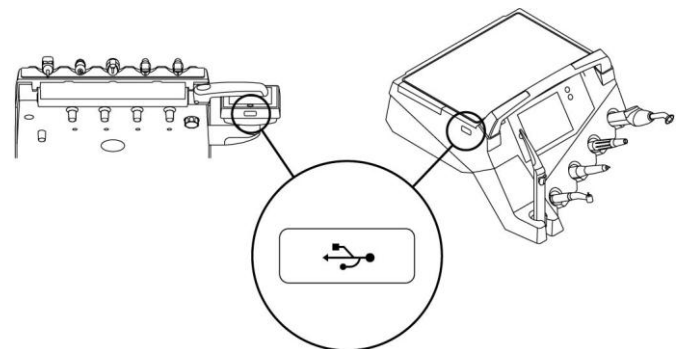

Removable instrument cords.

All instruments are provided with removable cords to make cleaning operations easier.

 **NOTE for CONTINENTAL version instrument boards:**
to remove cords, first remove instrument holder, then loosen the relevant plastic ring nuts.

 **NOTE for SIDE DELIVERY version instrument boards:**
to remove cords, simply loosen the relevant plastic ring nuts positioned under board.

-  **WARNING:**
- Before removing instrument cords, turn operating unit off.
 - After having turned operating unit off, drain syringe ducts by pressing the relevant air and water buttons directly on bowl until all spray water has flowed out.
 - **TURBINE, MICROMOTOR and SCALER instrument cords contain water; it is therefore recommended to remove cord by keeping the handpiece side end on the bowl.**
 - When refitting a cord, make sure that electric contacts are dry and that the plastic ring nut is well tightened.
 - Each cord must be refitted only and exclusively inside the corresponding instrument holder.

Clean the instrument cord using a suitable product (see Paragraph 1.4).

-  **WARNING:**
Instrument cords are **NOT** designed for sterilization in autoclave or by being cold soaked in solution.

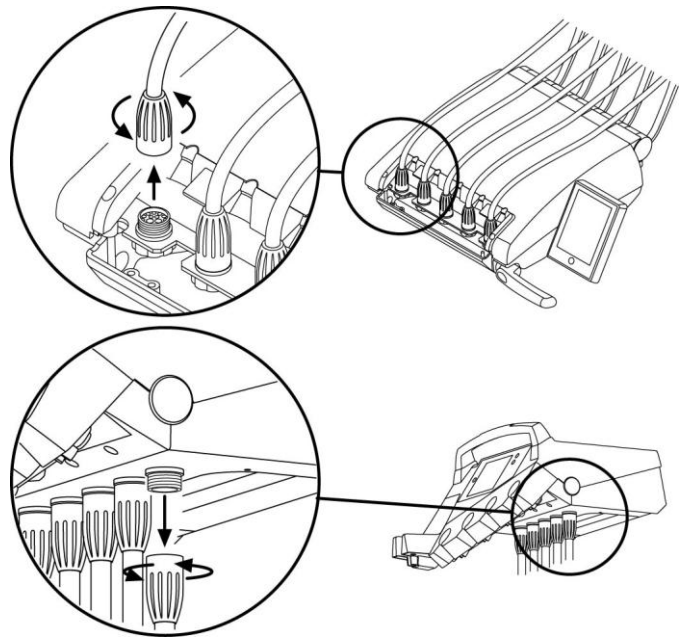

5.1. DENTIST'S CONTROL CONSOLE

Dental units L9 are equipped with a dentist's console with touch-screen interface, consisting of a backlit multi-touch glass capacitive touch panel and a wide 5.7" colour TFT display, with LED backlighting, 640x480 pixel resolution and 16.7 million colour imaging.

- (1) Control pad for the following models:
L9 CONTINENTAL
- (2) Control pad for the following models:
L9 SIDE DELIVERY

Description of capacitive buttons:

- Touch-screen lock button.
- Button to move dentist's board up (SIDE DELIVERY version).
- Button to move dentist's board down (SIDE DELIVERY version).

Description of icon buttons displayed on the touch panel:

- MAIN SETTINGS menu recall.
- Leg support movement control displaying (with dental chair A 3.0 ML only).
- Operator change.
- Warning icon displaying.
- Operating light On/Off.
- Assistant's call.
- S.H.S. system enabling/disabling
- Bowl counter-clockwise movement control (active with motor-driven bowl, only).
- Bowl clockwise movement control (active with motor-driven bowl, only).
- Water-to-cup control.
- Water-to-bowl control.
- Dental chair function saving.
- Emergency position recall.

NOTE: operation of dental chair buttons.



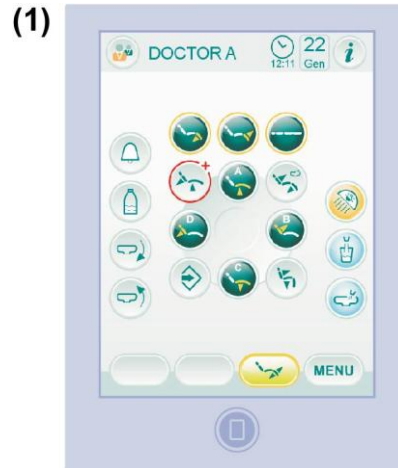





















- Button pressed shortly: automatic recall of set position.
- Button held pressed: manual positioning.











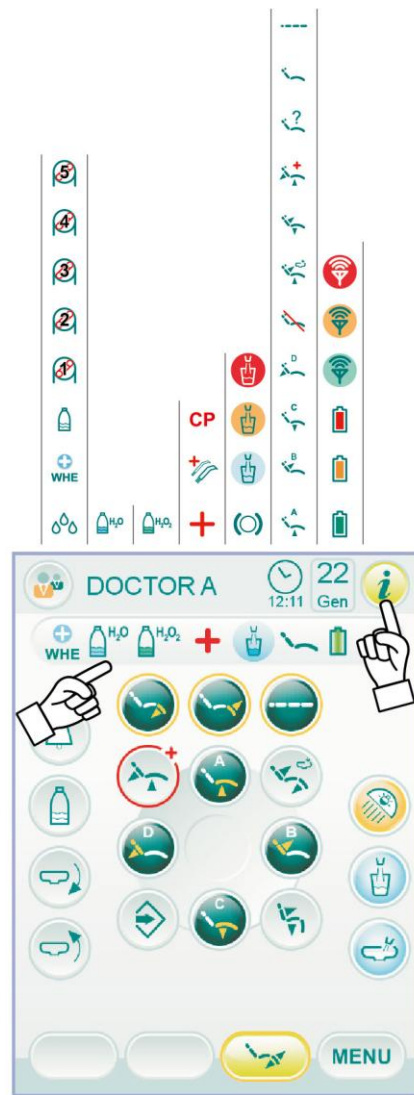

- Reset position recall.
- Rinsing position recall.
- Seat up and programmed position A recall.
- Backrest up and programmed position B recall.
- Seat down and programmed position C recall.
- Backrest down and programmed position D recall.
- Leg support down (with dental chair A 3.0 ML only).
- Leg support up (with dental chair A 3.0 ML only).
- Bed position recall (with dental chair A 3.0 ML only).

Warning icons.

By pressing the icon button  on the touch display it is possible, at any time, to display the warning icons showing dental unit operating status. Displayed warning icons are:

-  W.H.E. system working.
-  Distilled water delivery on.
-  Mains water delivery on.
-  Peristaltic pump on with quantity of delivered saline solution equal to 1.
-  Peristaltic pump on with quantity of delivered saline solution equal to 2.
-  Peristaltic pump on with quantity of delivered saline solution equal to 3.
-  Peristaltic pump on with quantity of delivered saline solution equal to 4.
-  Peristaltic pump on with quantity of delivered saline solution equal to 5.
-  Distilled water tank in reserve.
-  Duct disinfectant fluid tank in reserve.
-  BIOSTER cycle in progress.
-  Suction tube flushing cycle in progress.
-  Suction disabled because reservoir is full.
-  Green: wireless foot control battery charged.
-  Orange: wireless foot control battery 50% charged.
-  Red: wireless foot control battery flat.
-  Green: wireless foot control connected and active.
-  Orange: wireless foot control connected but not active.
-  Red: searching for wireless foot control connection.
-  Pantograph arm brake locked.
-  Light blue: COLD water in cup.
-  Orange: WARM water in cup.
-  Red: HOT water in cup.
-  Automatic dental chair programmed position A.







-  Automatic dental chair programmed position B.
-  Automatic dental chair programmed position C.
-  Automatic dental chair programmed position D.
-  Dental chair movements locked.
-  Automatic dental chair programme rinse position.
-  Automatic dental chair programme reset position.
-  Automatic dental chair programme emergency position.
-  Dental chair saving function on.
-  Dental chair position set manually.
-  Dental chair bed programme (with dental chair A 3.0 ML only).

5.1.1. USER'S INTERFACE

Upon turning on, the dental unit runs a short self-diagnosis cycle ending when the main screen with the name of the last set operator appears on the display.

From now onwards some settings of the operating unit can be edited through a simple menu system (see next paragraphs).

Navigation controls.

- To access the setting menus, touch icon button .
- To access the different sub-menus, simply touch the relevant icon button.
- Once menu is accessed, to edit a setting, simply touch the relevant icon button.
- Once menu is accessed, to edit a settable numerical value, simply touch icon buttons  or .
- To quit a menu, simply touch icon button .

User interface menu.

Settable functions:

- Operator selection (see paragraph 5.1.1.1.).
- General settings (see paragraph 5.1.1.2.).
- BIOSTER disinfection cycle setting (see paragraph 5.1.1.2.1.).
- FLUSHING cycle setting (see paragraph 5.1.1.2.2.).
- W.H.E. tank emptying system (see paragraph 5.1.1.2.3.).
- Water-to-bowl setting (see paragraph 5.1.1.2.4.).
- Water-to-cup setting (see paragraph 5.1.1.2.5.).
- Bowl movement management (see paragraph 5.1.1.2.6.).
- Foot control setting (see paragraph 5.1.1.2.7.).
- Operating light setting (see paragraph 5.1.1.2.8.).
- Other settings (see paragraph 5.1.1.2.9.).
- Time and date setting (see paragraph 5.1.1.2.10.).
- Stopwatch (see paragraph 5.1.1.2.11.).
- Favourite buttons customisation (see paragraph 5.1.1.2.12.).
- Operator database entry (see paragraph 5.1.1.2.13.).
- Language selection (see paragraph 5.1.1.2.14.).
- USB setup (see paragraph 5.1.1.2.15.).
- Image management (see paragraph 5.1.1.2.16.).
- APEX LOCATOR setting (see paragraph 5.1.1.2.17.).

Error messages.

During the starting cycle of self-diagnosis, the dental unit could detect some malfunctions of internal systems.

Should this be the case, an error message (see paragraph 10) will be displayed and will disappear only after the operator touches the TOUCH DISPLAY.

If fault does not represent a hazard, dental unit continues working.

Standby condition.

After approximately 10 minutes of inactivity, the dental unit switches to the energy-saving status (standby); this status is signalled by the ANTHOS logo appearing on the console display.

Standard operating conditions will be resumed as soon as any operation is carried out.

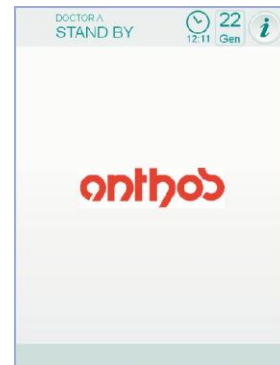
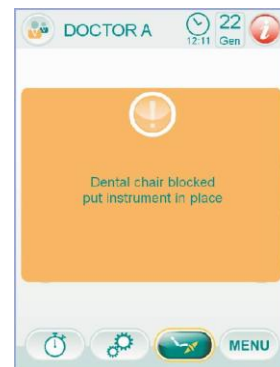
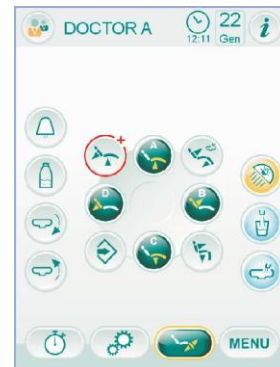

5.1.1.1. OPERATOR SELECTION

The console allows managing 4 different operators.
The following data can be set for each single operator:

- Name of operator.
- Turbine and scaler power adjustment.
- 3 operating modes for electric micromotor.
- 4 operating modes for scaler.
- Turning on and adjustment of the fibre optics of each single instrument.
- Turbine and scaler incremental power control or ON/OFF.
- Dental chair movement automatic programmes.
- Water unit setting parameters.
- Favourite buttons.
- Time set in stopwatch.

Operator selection.

From main screen, touch icon button and then select the desired operator among the 4 available ones.

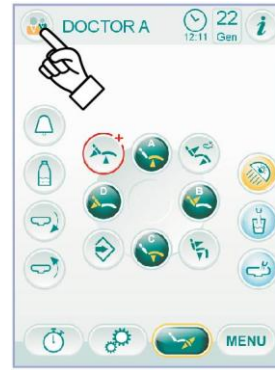

5.1.1.2. MAIN SETTINGS

From main screen, touch icon button to access the MAIN SETTINGS menu including the following icon buttons:

- BIOSTER disinfection cycle setting (if BIOSTER system is installed, only) (see paragraph 5.1.1.2.1.)
- FLUSHING cycle setting (if I.W.F.C. system is installed, only) (see paragraph 5.1.1.2.2.)
- W.H.E. tank emptying system (if W.H.E. system is installed, only) (see paragraph 5.1.1.2.3.)
- Water-to-bowl setting (see paragraph 5.1.1.2.4.)
- Water-to-cup setting (see paragraph 5.1.1.2.5.)
- Bowl automatic movement setting (with motor-driven bowl, only) (see paragraph 5.1.1.2.6.)
- Foot control setting (see paragraph 5.1.1.2.7.)
- Operating light setting (see paragraph 5.1.1.2.8.)
- Other settings (see paragraph 5.1.1.2.9.)
- Time and date setting (see paragraph 5.1.1.2.10.)
- Stopwatch (see paragraph 5.1.1.2.11.)
- Favourite button setting (see paragraph 5.1.1.2.12.)
- Operator database entry (see paragraph 5.1.1.2.13.)

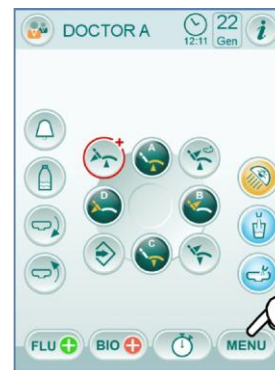

- Language selection (see paragraph 5.1.1.2.14.)
- USB SETUP (see paragraph 5.1.1.2.15.)
- Image management (see paragraph 5.1.1.2.16.)
- Access service menu (for Technical Service, only)
- APEX LOCATOR settings (if APEX LOCATOR is installed, only) (see paragraph 5.1.1.2.17.)

5.1.1.2.1. BIOSTER DISINFECTION CYCLE SETTING

This setting is the same for all operators.

From MAIN SETTINGS menu, carry out the following operations:

- Touch icon button to access the "BIOSTER disinfection cycle setting" sub-menu.



NOTE:

this sub-menu can be accessed also by keeping BIO button, located on assistant's board, pressed for at least 2 seconds.



NOTE:

This sub-menu cannot be accessed if the disinfectant fluid tank is in reserve (see paragraph 7.4.), if an instrument is extracted or if the W.H.E. system is in error conditions. An acoustic signal (BEEP) will warn about the impossibility to access the sub-menu.

- Set disinfectant fluid residence time by touching icon buttons or .



NOTE:

time setting ranges from a min. of 5 minutes to a max. of 10 minutes, with intervals of 30 seconds.



WARNING:

Recommended residence time with PEROXY Ag+: 10 minutes.

Recommended residence time with 3% oxygenated water (10 volumes): 10 minutes.

- Extract the instruments to be treated (the relevant icon will be displayed):

S1: syringe on dentist's board.

A: instrument in position A

B: instrument in position B

C: instrument in position C

D: instrument in position D

S2: syringe on assistant's board.

F: instrument on assistant's board.

CA: suction tubes.

BC: water-to-cup duct.



NOTE:

touch icon button to select / deselect water-to-cup duct disinfection.



NOTE:

if unit features the suction tube flashing system, flashing cycle can be activated by simply inserting suction tubes inside the relevant couplings (see paragraph 7.5).

- To start the disinfection cycle, touch icon button (see paragraph 7.4.).



NOTE:

disinfection cycle can be started also by shortly pressing the BIO button located on assistant's board.

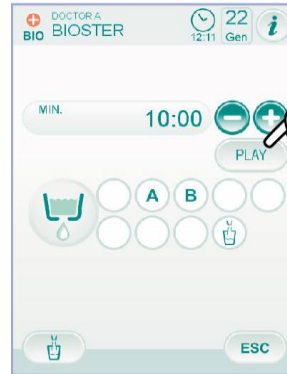
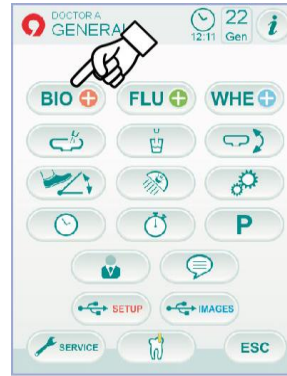

5.1.1.2.2. SETTING THE FLUSCHING CYCLE

This setting is the same for all operators.

From MAIN SETTINGS menu, carry out the following operations:

- Touch icon button to access the "FLUSHING cycle setting" sub-menu.



NOTE:

this sub-menu cannot be accessed if distilled water tank is in reserve (see paragraph 7.2.). A message on the console display together with an acoustic signal (BEEP) will warn about the impossibility to access the sub-menu.

- Set flushing time by touching icon buttons or .



NOTE:

time setting ranges from a min. of 1 minute to a max. of 5 minutes, with intervals of 1 minute.



NOTE:

when working on distilled water tank, it is recommended not to set a time above 2 minutes.

- Extract the instruments to be treated (the relevant icon will be displayed):

S1: syringe on dentist's board.

A: instrument in position A

B: instrument in position B

C: instrument in position C

D: instrument in position D

S2: syringe on assistant's board.

F: instrument on assistant's board.



NOTE:

the FLUSHING cycle will not start if at least one instrument has not been selected.

- To start the FLUSHING cycle, touch icon button (see paragraph 7.6.).

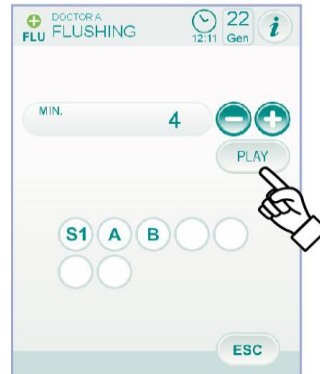
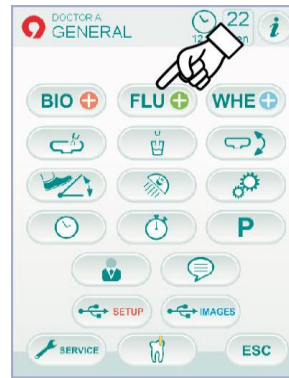

5.1.1.2.3. W.H.E. SYSTEM TANK EMPTYING

This function allows emptying the W.H.E. system water circuit (see paragraph 7.3.) in case dental unit must stay off for several days or if the water present inside system must be drained.

From MAIN SETTINGS menu, carry out the following operations:

- Touch icon button to access the "W.H.E. system tank emptying" sub-menu.
- Insert the special supplied cup (**e**) under the spout.
- Touch icon button to start the emptying cycle.



NOTE:

emptying cycle will not start if the SANASPRAY system is active or if the W.H.E. system is in error conditions.

- Once emptying cycle is over, dental unit can be turned off or the system can be reset in case work has to be resumed.

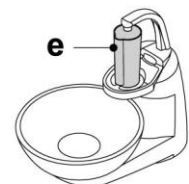
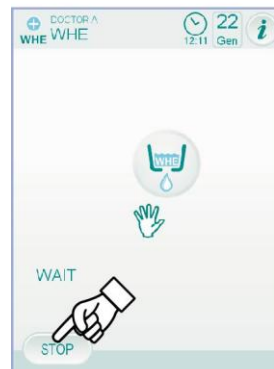

5.1.1.2.4. WATER-TO-BOWL SETTING

From MAIN SETTINGS menu, touch the icon button to access the "Water to bowl setting" sub-menu including the following icon buttons:

- Bowl flushing controller with dental chair rinsing position recall with dental chair reset position recall.
- Bowl flushing controller.
- Bowl flushing controller with dental chair return from rinsing position.
- Bowl flushing controller with cup call.
- Timed or ON/OFF bowl flushing setting.
- 11"** Bowl flushing time (in seconds).

- To select/deselect a function, touch the corresponding icon button.
- To edit bowl flushing time, touch icon buttons or .
- To confirm selected settings, simply quit this sub-menu by touching icon button .



5.1.1.2.5. WATER-TO-CUP SETTING

From MAIN SETTINGS menu, touch the icon button to access the "Water to bowl setting" sub-menu including the following icon buttons:

- Select COLD water to cup.
- Select LUKEWARM water to cup.
- Select HOT water to cup.
- 5.0"** Water-to-cup delivery time (in seconds).
- Distilled water tank depressurization controller with dental chair reset position call.
- Water-to-cup delivery controller with rinsing position call.
- Cup presence sensor activation/deactivation (if installed, only).

- To select/deselect a function, touch the corresponding icon button.
- To edit water-to-cup delivery time, touch icon buttons or .

NOTE:

water to cup filling time setting ranges from a min. of 1 second to a max. of 10 seconds, with intervals of 0.1 seconds.

- To confirm selected settings, simply quit this sub-menu by touching icon button .

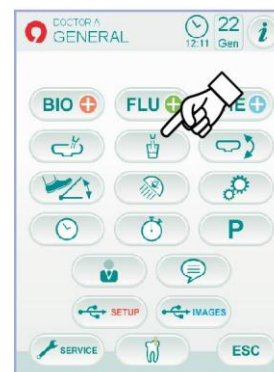

5.1.1.2.6. BOWL AUTOMATIC MOVEMENT SETTING

From MAIN SETTINGS menu, touch icon button to access the "Bowl automatic movement setting" sub-menu including the following icon buttons:

- Bowl rotation controller with dental chair reset position call.
 - Bowl rotation controller with dental chair rinsing position call.
 - Bowl rotation controller with dental chair automatic programme call.
- To select/deselect a function, touch the corresponding icon button.
 • To confirm selected settings, simply quit this sub-menu by touching icon button .

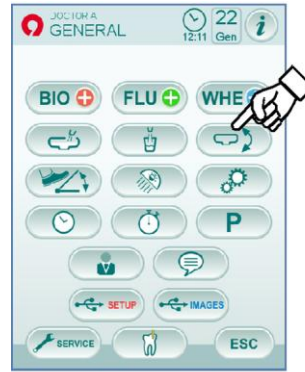

5.1.1.2.7. FOOT CONTROL SETTING

From MAIN SETTINGS menu, touch icon button to access the FOOT CONTROL SETTING sub-menu including the following icon buttons:

- Cable connection warning icon (with wireless foot control, only).
- Wireless connection status warning icon (with wireless foot control, only).
- Battery charge percentage (with wireless foot control, only).
- Foot control joystick with extracted instrument operation setting.

NOTE:
 the first 3 icons just warn the operator, while the fourth one allows selecting/deselecting foot control upper joystick operating mode. This setting is the same for all operators.

• To select/deselect foot control joystick operating mode, simply press the relevant icon button :

- Joystick enables dental chair manual movements (default).
- Joystick controls the following functions.
 - micromotor rotation direction reversal ON/OFF control, scaler ENDO function activation, camera MIRROR function enabling.
 - Peristaltic pump activation ON/OFF control.
 - Operating light ON/OFF control.
 - Instrument memory change.

• To confirm selected settings, simply quit this sub-menu by touching icon button .

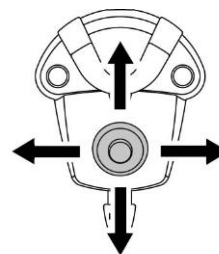
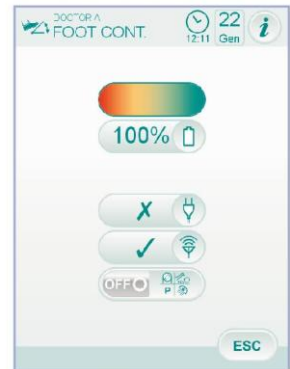

5.1.1.2.8. OPERATING LIGHT SETTING

From MAIN SETTINGS menu, touch icon button to access the OPERATING LIGHT SETTING sub-menu including the following icon buttons:

- Light turning off controller with dental chair rinsing position call.
- Light turning off controller with dental chair reset position call.
- Light brightness reduction controller with curing light instrument extraction (with VENUS PLUS -L light, only).

NOTE:
with turning off controller enabled, simply recall any dental chair movement to turn operating light on again.

NOTE:
with brightness reduction controller enabled, simply put curing light instrument back in place to re-activate the set brightness level.

- To select/deselect a controller, touch the corresponding icon button.
- To confirm selected settings, simply quit this sub-menu by touching icon button .

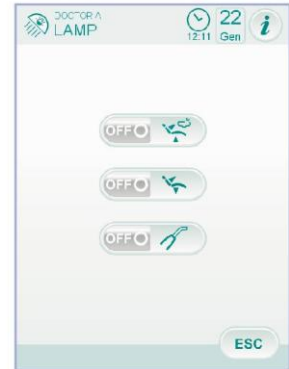

5.1.1.2.9. OTHER SETTINGS

These settings apply to all operators.

From MAIN SETTINGS menu, touch icon button to access the OTHER SETTINGS sub-menu including the following icon buttons:

- Pantograph arm brake release activation/deactivation (L9 CONTINENTAL model only).
- Display touch acoustic signal activation/deactivation.
- Dental chair movement activation/deactivation.
- Automatic dentist's board movement activation/deactivation (L9 SIDE DELIVERY model only)
- Brake sensitivity adjustment (L9 CONTINENTAL model only)..
- Display brightness adjustment.

- To enable or disable pantograph arm brake release, touch the relevant icon button.

NOTE:
brake unlockable status is signalled by the relevant icon on the TOUCH DISPLAY (see paragraph 5.1.).

WARNING:
For enhanced safety at work, this operation shall be compulsorily carried out if an external electric surgical scalpel is used.

- To enable or disable an acoustic signal whenever the TOUCH DISPLAY is touched.
- To enable or disable dental chair movements, touch the relevant icon button.

NOTE:
dental chair locked status is signalled by the relevant icon on the TOUCH DISPLAY (see paragraph 5.1.).

WARNING:
For enhanced safety at work, this operation shall be compulsorily carried out if an external electric surgical scalpel is used.

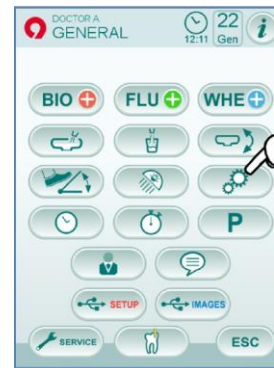

- To adjust brake activation sensitivity, touch the relevant icon buttons



NOTE:

value setting range: 1 to 5.

- To adjust display brightness, touch the relevant icon buttons or .



NOTE:

value setting range: 1 to 10.

- L9 SIDE DELIVERY models only: touch the corresponding icon button to activate or deactivate automatic dentist's board movement when the "Reset position" programme of the dental chair is recalled.
- To confirm selected settings, simply quit this sub-menu by touching icon button .

5.1.1.2.10. DATA AND TIME ADJUSTMENT

This setting is the same for all operators.

From the MAIN SETTINGS menu, touch icon button to access the TIME AND DATE SETTING sub-menu.

- To edit displayed data, touch the relevant icon buttons or .
- To select time displaying mode, simply press the relevant icon button:

AM / PM displaying.

24-hour displaying.

- To confirm selected settings, simply quit this sub-menu by touching icon button .



5.1.1.2.11. STOPWATCH

From the MAIN SETTINGS menu, touch icon button to access the STOPWATCH sub-menu.

- To edit displayed data, touch the relevant icon buttons or .



NOTE:

time setting range: 00:00:00 to 10:59:59.

- Once time has been set, touch icon button to start the countdown.



NOTE:

now you can quit this menu by touching icon button without stopping the countdown.

- To suspend the countdown touch icon button .
- To interrupt the countdown and take stopwatch back to the last set time, touch icon button .
- Once the set time has elapsed, the dental unit will issue an intermittent signal and the STOPWATCH menu will appear again on the TOUCH DISPLAY.

To stop the intermittent signal, touch icon button or any other button on the console.



NOTE:

the last set time is stored.

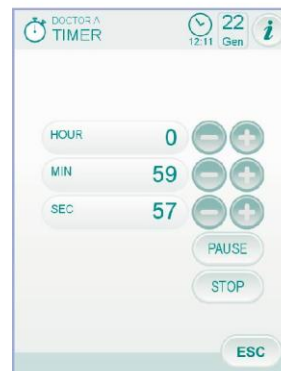

5.1.1.2.12. FAVOURITE BUTTON CUSTOMIZATION

This sub-menu allows selecting the function to be associated to the icons appearing at the bottom of main screen.

From the MAIN SETTINGS menu, touch icon button **P** to access the FAVOURITE BUTTON CUSTOMIZATION sub-menu showing the positions that can be edited with the icons of the currently-set functions.

- To edit the function for a specific position, simply touch the relevant icon buttons or .
- The following functions can be set:

- Vacuum.
- Other settings.
- Stopwatch.
- BIOSTER disinfection cycle setting (if BIOSTER system is installed, only).
- FLUSHING cycle setting (if I.W.F.C. system is installed, only).
- Foot control setting.
- W.H.E. tank emptying system (if W.H.E. system is installed, only).
- APEX LOCATOR settings (if APEX LOCATOR is installed, only).

- To confirm selected settings, simply quit this sub-menu by touching icon button **ESC**.

NOTE:

with the dental chair A 3.0 FL, the icons that can be set are 3.



5.1.1.2.13. OPERATOR DATABASE ENTRY

From the MAIN SETTINGS menu, touch icon button to access the OPERATOR DATABASE ENTRY sub-menu.

NOTE:

edited database always refers to the operator set in main screen.

- To enter the desired text, touch the icon buttons of the different letters (max. 20 characters).
- To enter capital letters, touch icon button .
- To enter digits or special characters, touch icon button .
- To delete any errors, touch icon button and delete characters from left to right.
- Once text has been entered, touch icon button **OK** to quit the sub-menu and automatically save entered data.
- Touch icon button **ESC** to quit the sub-menu without storing the changes.



5.1.1.2.14. LANGUAGE SELECTION

This setting is the same for all operators.

From the MAIN SETTINGS menu, touch icon button  to access the LANGUAGE SELECTION sub-menu.

- To edit language, touch the icon button of the corresponding flag.
- To confirm the selected language, simply quit this sub-menu by touching icon button .



5.1.1.2.15. USB SETUP

The USB Setup screen allows managing the following activities:

- saving the current user profile on a USB flash drive,
- downloading a user profile for the "guest" operator from a USB flash drive.

From the MAIN SETTINGS menu, touch icon button  to access the USB SETUP sub-menu.

Proceed as follows:

- Insert a USB flash drive inside the special port on the dentist's board console (see paragraph 5.).
- Touch icon button  to download a "guest" user profile from a USB flash drive.



NOTE:

the "guest" profile will be automatically uploaded in the fourth operator position by overwriting the existing profile, if any.

- Touch icon button  to save the current user profile in a USB flash drive.



NOTE:

the settings of all instruments on dentist's board, stopwatch, light and foot control will be saved.

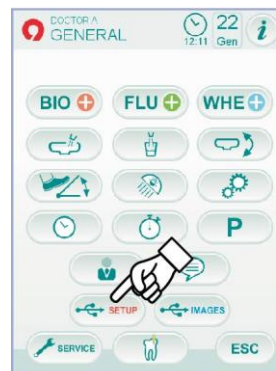

5.1.1.2.16. IMAGE MANAGEMENT

The dental image displaying and processing mode can be entered through the "Image management" screen.

The images present in the dental unit local memory or in a USB key can be managed and the MYRAY iRYS image management software can be interfaced with (see paragraph 5.1.1.2.16.1.).

PNG formats, both at 8 bit / pixel and at 16 bit / pixel, JPG or TIFF formats with resolutions between 640x480 and 2500x2500 pixels are supported.

Memory used.

According to the memory used, the following icons are displayed:

 IMAGES USB key connected.

 IMAGES PC connection through iRYS.

 IMAGES Local memory.

Changing the memory used.

The memory used can be changed as follows:

- Touch the icon in the top left corner of the display.
- Choose the desired memory.

 **NOTE:**
the icon in the top left corner displays the currently used memory.

Operation with USB key.

Proceed as follows:

Insert a USB key inside the special port on the dentist's board console (see paragraph 5.).

From the MAIN SETTINGS menu, touch icon button  to access the USB IMAGES sub-menu.

Flash drive contents will be scanned to show a list of folders .

 **NOTE:**
the operation might require a few minutes to be completed, based on the size of the flash drive and on the number of images it contains.

 **NOTE:**
while consulting the images, do not disconnect the USB flash drive.

"List" screen.

- Touch a folder to display the list of the images it contains.
- Touch the sidebar to scroll the image list.
- Touch the BACK element, always on top of the list, to go back to previous folder.
- Available controls:

 Display other available options.

 Create a new folder.

 Display the images contained inside current folder as thumbnails.

"Thumbnail" screen.

- Scroll image thumbnails by touching on the left or on the right of the central image.
- Touch the image to display it in full screen mode.
- Available controls:

 Overturn image.

 Turn image clockwise.

 Recall main controls of main screen.

 Delete image (a confirmation prompt will appear).

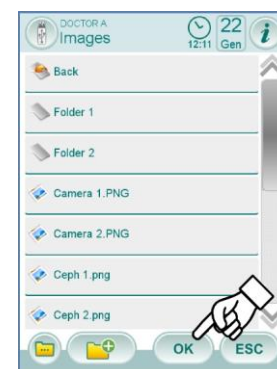
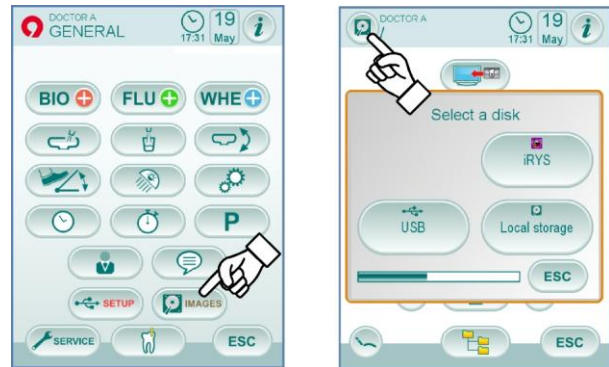



Go back to "list" screen.



Display images on monitor (only with monitor connected to camera module).

"Image" screen.

- Touch the image to zoom it and move it sideways.
- Available controls:



Image automatic improvement.



Increase image brightness.



Reduce image brightness.



Restore image original appearance.



Go back to "thumbnail" screen.



NOTE:

changes made to the image are automatically saved.

USB flash drive removal.

Before removing the USB flash drive, go back to main parameter menu or to other operative screens.

Operation with local memory.

The operation with local memory is the same as the operation with USB key.

5.1.1.2.16.1. IMAGE MANAGEMENT THROUGH iRYS

- From the MAIN SETTINGS menu, touch icon button to access the iRYS patient archive.



NOTE:

for correct PC connection, refer to the user's manual supplied with iRYS.



NOTE:

the iRYS button is not shown when a USB key is connected.



"List" screen.

- The "list" screen displays any patient folder open in iRYS and the last 3 patients consulted. Moreover, the following controls are available:

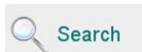

Search

Browse for a patient folder by entering the name.

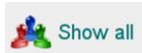

Show all

Show all the available patient folders in alphabetical order.



NOTE:

the "Show All" button appears only if the total number of patients is lower than 100.



NOTE:

the console does not allow to create a new patient folder in iRYS.

- Select the desired patient - the corresponding general data sheet will be displayed in order to be checked.
- Touch icon button to access the "thumbnail" screen.



"Thumbnail" screen.

- Scroll image thumbnails by touching on the left or on the right of the central image.
- Touch the image to display it in full screen mode.
- Available controls:



Overturn image.



Turn image clockwise.



Recall main controls of main screen.



Delete image (a confirmation prompt will appear).



Go back to "list" screen.



Display images on monitor (only with monitor connected to camera module).

Scroll image thumbnails by touching on the left or on the right of the central image.

- Touch the image to display it in full screen mode.



NOTE:

any image change performed from the console are NOT saved in iRYS.



"Image" screen.

- Touch the image to zoom it and move it sideways.
- Available controls:



Image automatic improvement.



Increase image brightness.



Reduce image brightness.



Restore image original appearance.



Go back to "thumbnail" screen.



NOTE:

any image change performed from the console are NOT saved in iRYS.



5.1.1.2.17. APEX LOCATOR SETTING

The alarm threshold of the electronic APEX LOCATOR (see paragraph 5.11.) can be set using this sub-menu.

From the MAIN SETTINGS menu, touch icon button to access the APEX LOCATOR SETTING sub-menu.

- Set alarm threshold using icon buttons or .
An orange dash on left-hand bargraph will display the selected value.

NOTE:

value setting range: 0 to +2.

- Touch the relevant icon button to enable/disable the alarm signal once set threshold is reached:



Alarm active.



Alarm not active.

- To confirm the selected value, simply quit this sub-menu by touching icon button .

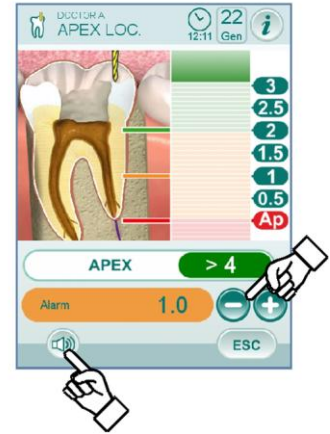

5.1.2. SETTING THE DENTAL CHAIR "AUTOMATIC RETURN" AND "RINSE POSITION"

This setting is specific for each single operator.

From main screen, carry out the following operations:

- Bring the dental chair into the desired position using manual movement icon buttons.

NOTE:

in the Rinsing Position, the maximum seat height that can be stored is the safety height (no interference between the seat and the bowl).

NOTE:

the position of the bowl is stored if the bowl is motor-driven.

NOTE for L9 SIDE DELIVERY models:

the position of the dentist's board cannot be stored.

- Press icon button for at least 2 seconds to activate saving mode. Save mode activation is signalled by a short acoustic signal (BEEP) and by the corresponding icon (**A**) on the TOUCH DISPLAY.

NOTE:

to quit storage mode without performing any change, press icon button again for at least 2 seconds.

- Press "Reset position" or "Rinsing position" icon buttons to associate the position to the button. The appearance of icon (**B**) relating to the selected programme on the TOUCH DISPLAY will confirm that it has been saved.

NOTE:

the "Rinsing Position" button moves backrest and seat to rinsing position. When icon button "Rinsing Position" is pressed again, backrest and seat will go back to the previous position.

NOTE:

to go back to work position from the "Reset position", simply press any programmed work position.

NOTE for L9 SIDE DELIVERY models:

if set (see paragraph 5.1.1.2.9.), by pressing the "Reset position" icon button, the dentist's board automatically moves to the top position.



>2 sec

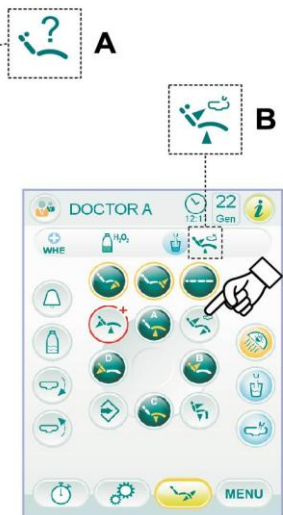

5.1.3. DENTAL CHAIR POSITION PROGRAMMING

This setting is specific for each single operator.

From main screen, carry out the following operations:

- Bring the dental chair into the desired position using manual movement icon buttons.
- Press icon button  for at least 2 seconds to activate saving mode.



NOTE:

save mode activation is signalled by a short acoustic signal (BEEP) and by the corresponding icon (**A**) on the TOUCH DISPLAY.

- Press icon buttons (**A**) or (**B**) or (**C**) or (**D**) to associate position to button (ex. C).



NOTE:

the appearance of icon (**B**) relating to the selected programme (ex. C) on the TOUCH DISPLAY will confirm that it has been saved.



NOTE:

to recall a programmed position, shortly press the icon button where this position had been previously saved.

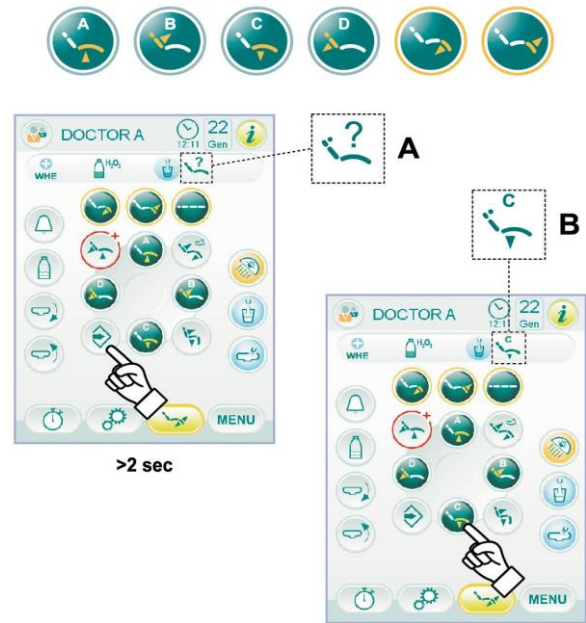

5.1.4. EMERGENCY BUTTON

This button can be used in the event of an emergency to bring the patient into the Trendelenburg position.



NOTE:

the Trendelenburg position is already set and cannot be changed.



5.1.5. TOUCH-SCREEN LOCK BUTTON (with dental chair A 3.0 ML only)

Press this button to enable/disable the TOUCH DISPLAY screen in order to easily carry out console cleaning operations.



NOTE:

the locked screen mode is signalled by a clear message on the TOUCH DISPLAY.

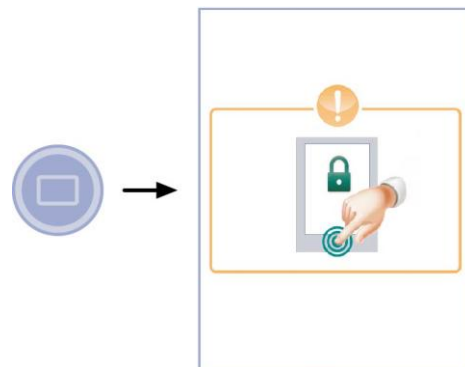

5.1.6. BED POSITION RECALL BUTTON

This icon button automatically moves backrest and leg support to a horizontal position suitable for surgical procedures with a sedated patient.

This saved position can always be edited and is specific for each single operator.

From main screen, carry out the following operations:

- Press icon button to move chair to bed position.
- Bring the dental chair into the desired position using manual movement icon buttons.
- Press icon button for at least 2 seconds to activate saving mode.



NOTE:

save mode activation is signalled by a short acoustic signal (BEEP) and by the corresponding icon (**A**) on the TOUCH DISPLAY.

- Press icon button again to save the new position.



NOTE:

the appearance of icon (**B**) relating to the bed position programme on the TOUCH DISPLAY will confirm that it has been saved.

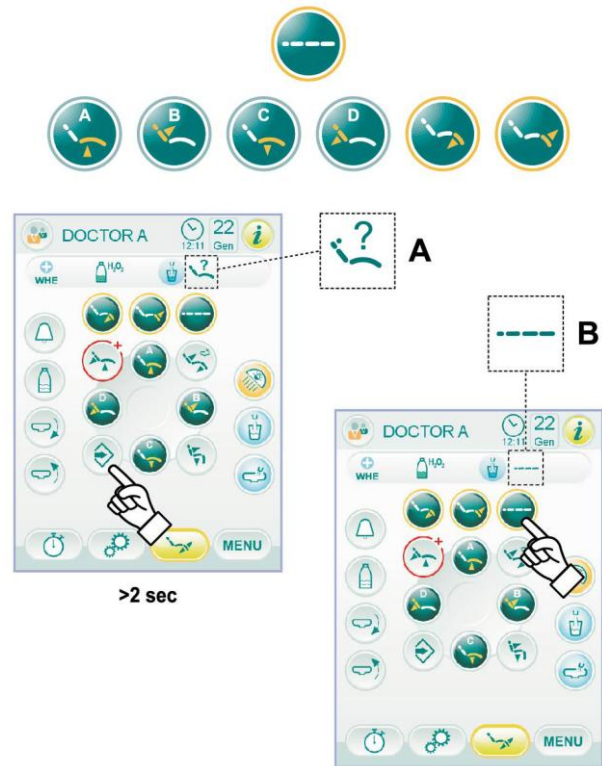

5.2. FOOT CONTROL

3 types of foot controls are available:

- (1) "Multifunction" foot control.
- (2) "Push-pedal" foot control.
- (3) "Power Pedal" foot control.



NOTE:

the "multifunction" and "push-pedal" foot controls can also be supplied in WIRELESS version.

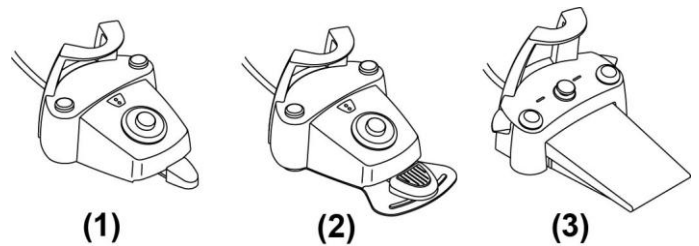

5.2.1. "MULTIFUNCTION" FOOT CONTROL

Description of the parts.

- 1 Handle.
- 2 Control pedal.
- 3 Dental chair movements.
- 4 Chip-air/Patient rinsing position recall control.
- 5 Water Clean System/Automatic dental chair return control.
- 6 LED (not active).
- 7 Battery charge LED (wireless version only).

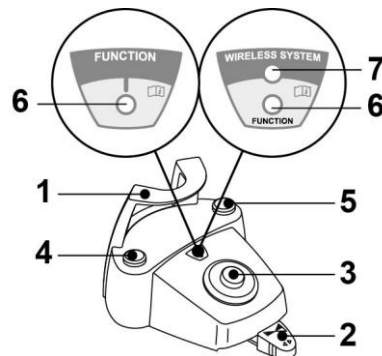

Control pedal (2).

With instrument removed

- Starts the instrument.
- Adjusts the rpm of rotary instruments.
- To the right: operation with spray (if foreseen for selected instrument).



NOTE:

at the end of work, air is automatically blown to eliminate any drops of liquid remaining in the spray ducts.



WARNING:

These dental chair functions are activated by keeping the pedal at the end of the travel for at least 2 seconds.

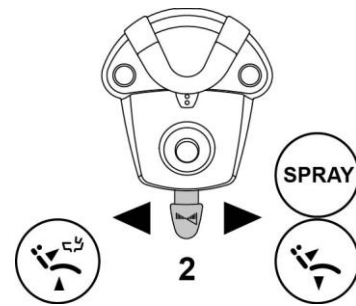

Dental chair movement Joystick operation (3).

It controls the following movements:



Dental chair seat up.



Dental chair backrest up.



Dental chair seat down.



Dental chair backrest down.

To stop movement, release the control.



NOTE:

all the buttons used to move the dental chair are inoperative when an instrument is removed and the foot control pedal is actuated.



NOTE:

it is possible to edit the joystick operation once the instrument is extracted (see paragraph 5.1.1.2.7.).

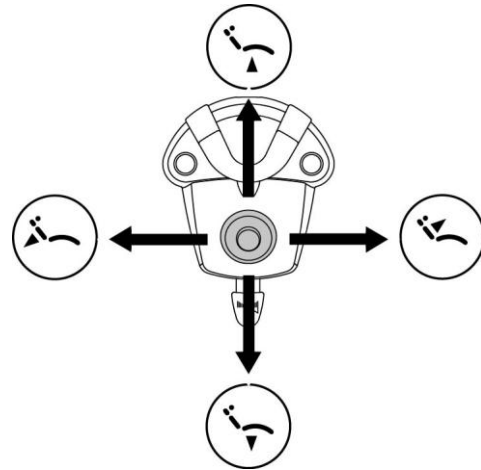

Left-hand button operation (4).

- Holding down the button for at least 2 seconds with instrument extracted:

Chip-air control: sends a jet of air to the Turbine or the Micromotor.

Air flow is activated by pressing the button; the jet of air is interrupted as soon as button is released.

- Holding down the button for at least 2 seconds with the instruments in rest position:

activation of the "Patient rinsing position" program.



NOTE:

pressing the button a second time returns dental chair back into working position.

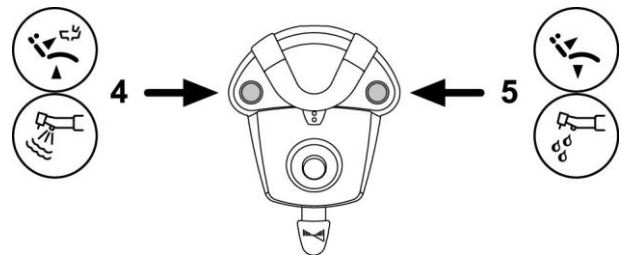

Right-hand button operation (5).

- Holding down the button for at least 2 seconds with instrument extracted:

Water Clean System Control: sends a jet of running water to instruments such as the Turbine, the Micromotor and the Scaler for rinsing the spray ducts. Water is delivered by pressing the button. Water is no longer delivered as soon as the button is released and air is automatically blown to eliminate any drops of liquid remaining inside the spray ducts.

- Holding down the button for at least 2 seconds with the instruments in rest position:

Activation of the "Automatic dental chair return" programme.

Wireless version.

This foot control can also be supplied in wireless version (see Paragraph 5.2.4).

Protection against liquid penetration.

The foot control is protected against liquid penetration. Degree of protection: IPX1.

Cleaning.

Clean the foot control using a suitable product (see Paragraph 1.4).

NOTE:

if the foot control slips on the floor, remove any dust from the slip-proof rubber found under the base with a dry cloth.

5.2.2. "PUSH-PEDAL" FOOT CONTROL

Description of the parts.

- 1 Handle.
- 2 Control pedal.
- 3 Dental chair movements.
- 4 Chip-air/Patient rinsing position recall control.
- 5 Water Clean System/Automatic dental chair return control.
- 6 Spray operation LED.
- 7 Battery charge LED (wireless version only).

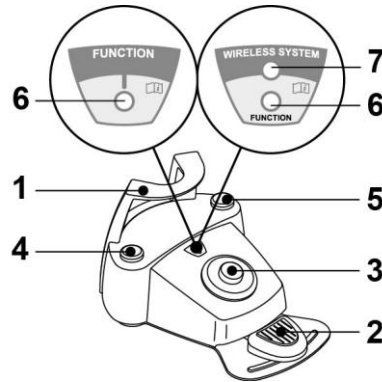

Control pedal (2).

Operation:

- Remove the instrument.
- Push the control pedal (a) to start the instrument.
- Adjust the rpm/power of the instrument with the control pedal:
 - to the right: increase;
 - to the left: decrease.

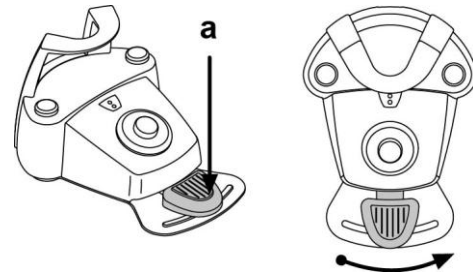

NOTE:

the control pedal adjusts the speed/power of the instrument from the minimum to the maximum value set from the dentist's board.

- To stop the instrument, simply release the control pedal (a).

NOTE:

with the spray active, at the end of the operation a blast of air is automatically activated to remove any residual drops of liquid in the spray ducts.



WARNING:

Instrument spray is activated and deactivated by pressing the buttons (4) or (5).
A short acoustic signal warns of the switching.
When the LED (6) is on, it indicates operation with spray.

Dental chair movement Joystick operation (3).

It controls the following movements:

- Dental chair seat up.
- Dental chair backrest up.
- Dental chair seat down.
- Dental chair backrest down.

To stop movement, release the control.

NOTE:

all the buttons used to move the dental chair are inoperative when an instrument is removed and the foot control pedal is actuated.

NOTE:

it is possible to edit the joystick operation once the instrument is extracted (see paragraph 5.1.1.2.7.).

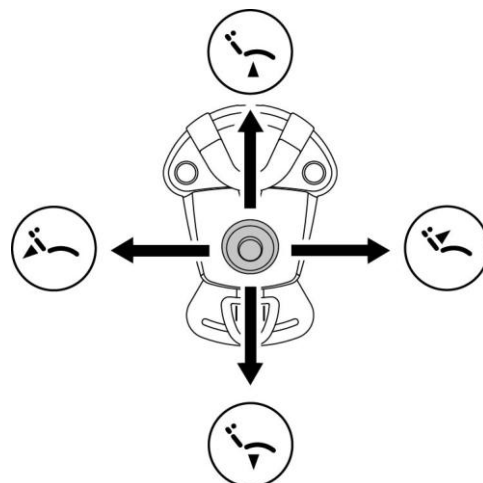

Left-hand button operation (4).

Operation:

- Holding down the button for at least 2 seconds with the instruments in rest position:

Activation of the "Patient rinsing position" program.

NOTE:

pressing the button a second time returns dental chair back into working position.

- Holding down the button for at least 2 seconds with instrument extracted:

Chip-air control: sends a jet of air to the Turbine or the Micromotor.

Air flow is activated by pressing the button; the jet of air is interrupted as soon as button is released.

NOTE:

the control works only when the Turbine and Micromotor are in working position.

- Press the button shortly with the instrument extracted:

Activation or deactivation of instrument spray.

WARNING:

A short acoustic signal warns of the switching.
When the LED (6) is on, it indicates operation with spray.

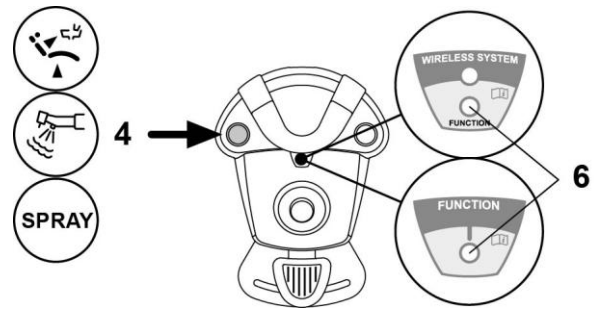

Right-hand button operation (5).

Operation:

- Holding down the button for at least 2 seconds with the instruments in rest position:

Activation of the "Automatic dental chair return" programme.

- Holding down the button for at least 2 seconds with instrument extracted:

Water Clean System Control: sends a jet of running water to instruments such as the Turbine, the Micromotor and the Scaler for rinsing the spray ducts.

Water is delivered by pressing the button. Water is no longer delivered as soon as the button is released and air is automatically blown to eliminate any drops of liquid remaining inside the spray ducts.

- Press the button shortly with the instrument extracted:

Activation or deactivation of instrument spray.

WARNING:

A short acoustic signal warns of the switching.
When the LED (6) is on, it indicates operation with spray.

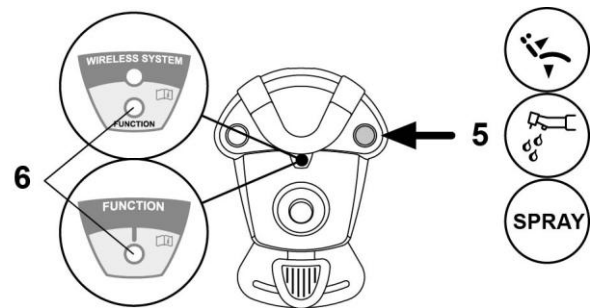

Wireless version.

This foot control can also be supplied in WIRELESS version (see "WIRELESS foot control" paragraph).

Protection against liquid penetration.

The foot control is protected against liquid penetration. Degree of protection: IPX1.

Cleaning.

Clean the foot control using a suitable product (see Paragraph 1.4).

NOTE:

if the foot control slips on the floor, remove any dust from the slip-proof rubber found under the base with a dry cloth.

5.2.3. "POWER PEDAL" FOOT CONTROL

Description of the parts.

- 1 Handle.
- 2 Foot control.
- 3 Dental chair movements.
- 4 Chip-air control or activation/deactivation of instrument spray function.
- 5 Water Clean System control or activation/deactivation of instrument spray function.
- 6 Programme "B" recall or automatic dental chair return activation.
- 7 Programme "A" recall or patient rinse position activation.
- 8 Spray operation LED.

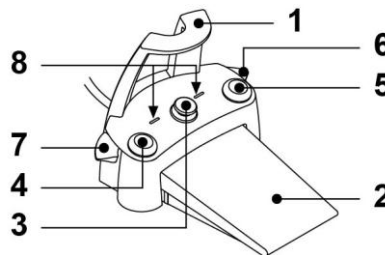

Foot control operation (2).

- With instrument removed
 - Pushing the pedal (a), the instrument is started.
The instrument rpm (or power) can be adjusted by varying the pressure exerted on the foot control.



NOTE:

the foot control adjusts the speed/power of the instrument from the minimum to maximum value set from the instrument board.

- Release the foot control to stop instrument operation.



NOTE:





with the spray active, at the end of the operation a blast of air is automatically activated to remove any residual drops of liquid in the spray ducts.

- With instrument in rest position

When the foot control is pressed, all automatic dental chair movements are automatically blocked.

Dental chair movement Joystick operation (3).

It controls the following movements:

-  Dental chair seat up.
-  Dental chair backrest up.
-  Dental chair seat down.
-  Dental chair backrest down.

To stop movement, release the control.



NOTE:

all dental chair movements are blocked when an instrument is being used or the BIOSTER system is running.



NOTE:

it is possible to edit the joystick operation once the instrument is extracted (see paragraph 5.1.1.2.7.).

Left-hand button operation (4).

- Holding down the button for at least 2 seconds with instrument extracted:

Chip-air control: sends a jet of air to the Turbine or the Micromotor. Air flow is activated by pressing the button; the jet of air is interrupted as soon as button is released.

- Press the button shortly with the instrument extracted:
Activation or deactivation of instrument spray.



WARNING:

**A short acoustic signal warns of the switching.
When the LED (8) is on, it indicates operation with spray.**

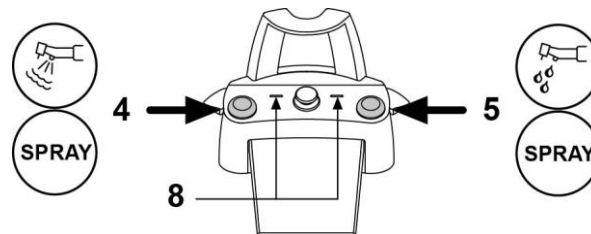
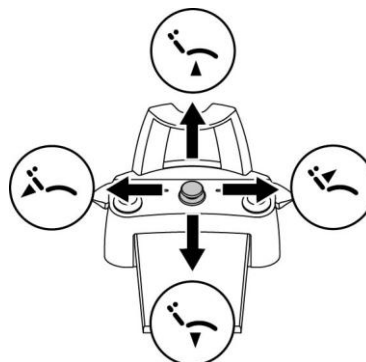
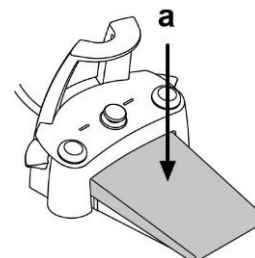

Right-hand button operation (5).

- Holding down the button for at least 2 seconds with instrument extracted:

Water Clean System Control: sends a jet of running water to instruments such as the Turbine, the Micromotor and the Scaler for rinsing the spray ducts. Water delivery is activated by pressing the button (5); when the button is released, the jet of water is interrupted and a blast of air is automatically activated to remove any residual drops of liquid in the spray ducts.

- Press the button shortly with the instrument extracted:

Activation or deactivation of instrument spray.



WARNING:

A short acoustic signal warns of the switching.
When the LED (8) is on, it indicates operation with spray.

Right-hand lever operation (6).



NOTE:

lever operates only with instruments in rest position.

For safety reasons, the selected function starts only after the lever has been briefly actuated and then released.

- Lever pushed downwards:
"Automatic dental chair return" programme activated.
- Lever pulled upwards:
Dental chair programme "B" activation.

Left-hand lever operation (7).



NOTE:

lever operates only with instruments in rest position.

For safety reasons, the selected function starts only after the lever has been briefly actuated and then released.

- Lever pushed downwards:
Activation of the "Patient rinsing position" programme.



NOTE:

when the lever is actuated the second time, the dental chair reaches its work position.

- Lever pulled upwards:
Dental chair programme "A" activation.

Protection against liquid penetration.

The foot control is protected against liquid penetration. Degree of protection: IPX1.

Cleaning.

Clean the foot control using a suitable product (see Paragraph 1.4).



NOTE:

if the foot control slips on the floor, remove any dust from the slip-proof rubber found under the base with a moist cloth.

5.2.4. WIRELESS FOOT CONTROL

The "side travel" and "push-pedal" foot controls can also be supplied in WIRELESS version.

The wireless foot control contains a ZIGBEE transmitter module (module certified for Europe, Canada and the USA).

Warnings for use.



WARNING:

- Avoid keeping the WIRELESS foot control in proximity of other RF sources, such as wireless LAN cards, other radio devices, home RF devices, microwave ovens. The recommended distance is at least 2 metres in the case of microwave ovens and 1 metre in all other cases.
- Even though the electromagnetic field irradiated by the foot control is insignificant, it is advisable NOT to use it in proximity of life support equipment (e.g. pacemakers or heart stimulators) and hearing aids. Before using any electronic device in health facilities, always check that it is compatible with the other equipment present.
- Exclusively use the dental unit to charge the battery of the WIRELESS foot control.
- The internal battery may only be replaced by a qualified technician.

Warnings for first use.

It is advisable to fully charge the foot control battery before using it for the first time.

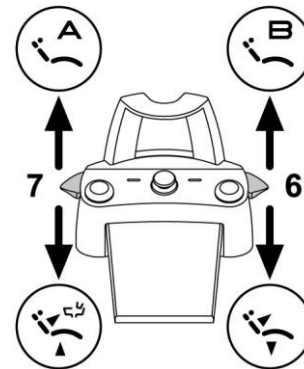

WIRELESS foot control operation.

The WIRELESS foot control operates exactly in the same way as the wired version, therefore refer to the paragraphs above paying WARNING to the specific model used.

In addition, the WIRELESS foot control has a specific LED (7) that indicates the battery charge and the communication status with the dental unit.

LED (7) indications.

The colour of the LED indicates the battery charge, while the type of flashing indicates the communication status with the dental unit.

Battery charge:

COLOUR	DESCRIPTION (CABLE DISCONNECTED)	DESCRIPTION (CABLE CONNECTED)
GREEN	Battery charge (>75%)	Battery charged
ORANGE	Battery charge (<50%)	Battery charging
RED	Battery needs charging (<25%)	Battery charge error
Off	Battery flat	Dental unit off or foot control fault

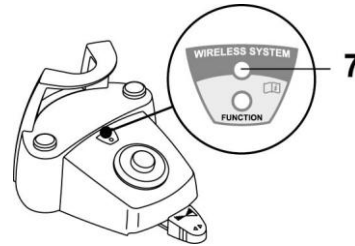

Communication status:

FLASHING	DESCRIPTION
Slow	Connection active in wireless mode
Fast	Connection active with charging cable inserted
Double	Connection search
On fixed	Communication error



NOTE:

this information can be also displayed on the TOUCH DISPLAY through the special icons (A) or (B) (see paragraph 5.1.) or inside the special menu controlling the foot control (see paragraph 5.1.1.2.3.).



Battery characteristics.

The WIRELESS foot control is equipped with a rechargeable Lithium-Polymer battery (Li-Poly, 3.7V, 5200 mAh type Guangzhou Markyn Battery Co. Model 9051109).

The battery life is approximately 2 months (estimating 8 hours of consecutive daily operation) with the battery fully charged and fully efficient. The battery efficiency reduces with age. It is estimated that the efficiency is reduced to 60% after 500 complete recharging cycles. Also in this condition, the battery should last about 1 month.



NOTE:

when the battery efficiency is so reduced as to be deemed unsatisfactory to support the daily usage requirements, have it replaced by a qualified technician (original spare part no. 97901336).



WARNING:

Do not attempt to replace the battery yourself.

Limited battery warranty.

The battery in the foot control is covered by a 6-month warranty from the date of installation.

Recharging the battery.

When the batteries in the WIRELESS foot control need to be recharged, Proceed as follows:

- Open the protective cap of the connector on the rear of the foot control and connect the recharging cable.
- Connect the other end of the recharging cable to the dental unit (see figure).

At this point, the foot control is in the battery charging phase (battery charging warning LED on) even though remaining fully functional.



NOTE:

the battery is fully recharged in about 6 hours.



WARNING:

Exclusively use the dental unit to charge the battery of the WIRELESS foot control.

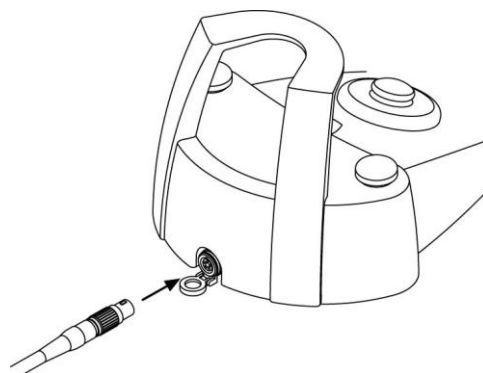

Natural battery discharge.

Should the battery not be used for long periods of time, it may slowly discharge all the same.

If unused for long periods of time, it is advisable to always fully charge the battery before use.

Maintenance and disposal

The wireless foot control does not contain parts that can be repaired directly by the user.

In the event of a malfunction, do not attempt to carry out maintenance operations,

but directly contact the manufacturer or his local distributor at the numbers indicated in the warranty certificate.

At the end of its lifetime, the battery must be replaced by a specialised technician at a Service Centre.

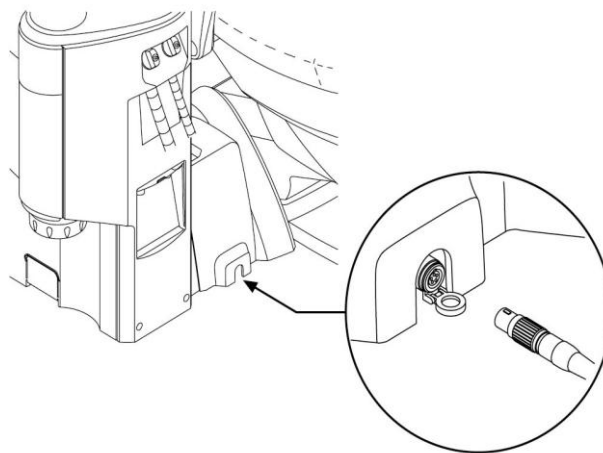

5.3. SYRINGE

Description of the instrument.

- a Nozzle.
- b Handpiece.
- c Syringe release button.
- d Air button.
- e Water button.
- f Hot/cold selector (only for 6-function syringes).
- g Hot/cold indicator LED (only for 6-function syringes).



WARNING:

The instrument is supplied non-sterile. It is recommended to use disposable protections and nozzles.

Technical specifications.

- Operating time:
 - syringe 3F: continuous operation,
 - syringe 6F: 5 sec. operation, 10 sec. rest,
 - syringe 6F (with fibre optics): 5 sec. operation, 10 sec. rest.
- Power supply:
 - 6F and 6F-L syringe (CEFLA s.c. models): 24 Vac; 50/60 Hz; 2 A; 50 W.
- Classification in accordance with standard EN 60601-1:
 - 6F and 6F-L syringe (CEFLA s.c. models): CLASS II, type B.
- Installation diagram: consult the technical installation manual (see paragraph 11.).

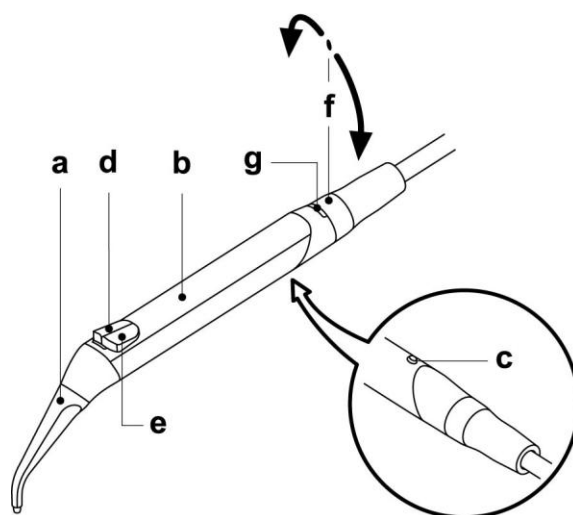

Use.

- Place the instrument in its working position.



NOTE:

instrument activation is highlighted by the relevant managing screen appearing on the TOUCH DISPLAY.

- Button (e) = water;
Button (d) = air;
Button (e + d) = spray.
- 6F syringe, operation with hot water, air and spray: turn the selector switch [f] clockwise (LED g on).
- 6F syringe, operation with cold water, air and spray: turn the selector switch [f] counter clockwise (LED g off).
- The icon buttons available on the TOUCH DISPLAY are:



Fibre optics on/off (with 6F-L syringe, only).



Activation/deactivation independent water supply (with SANASPRAY system, only).



Main screen controls recall.

Fibre optic brightness adjustment.

- To adjust fibre optic brightness, touch icon button (for at least 2 seconds).
- Adjust brightness level by touching icon buttons or or scrolling the bargraph with your finger.



NOTE:

value setting range: 1 to 16.

- To confirm the selected brightness, simply quit this sub-menu by touching icon button .



NOTE:

fibre optics will turn automatically off after 30 seconds.

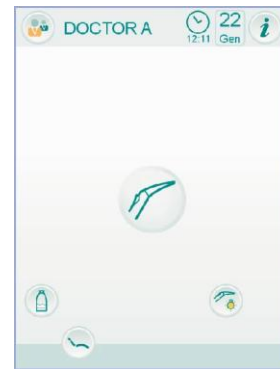

>2 sec

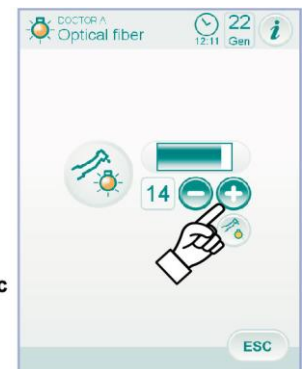

Removing the grip.

- The nozzle (a) is screwed onto the grip (b).
- Turn the selector switch counter-clockwise (LED g off) and press button (c) to take the grip off the syringe casing.

Syringe removable cord.

Syringe features a removable cord to make cleaning operations easier (see paragraph 5.).

Cleaning.

Use soft disposable paper towel dampened with detergents/disinfectants.



WARNING:

- Do not soak the syringe in disinfectant liquids or detergents.
- Recommended products: harsh products and/or products containing acetone, chlorine and sodium hypochlorites.

Disinfection.

Syringe grip and spout: see paragraph 1.5.



NOTE:

bag before sterilising.

5.4. TURBINE

Connecting the handpiece and changing the drill.
Refer to the specific instructions provided with the handpiece.

Use.

WARNING:
Read the instructions for use of the various turbines.

- **Operating times: work 5 min., rest 5 min.**
- The cock (f) is used to adjust spray water quantity.
- The cock (e) adjusts the amount of air spray for all the instruments.
- Place the instrument in its working position.

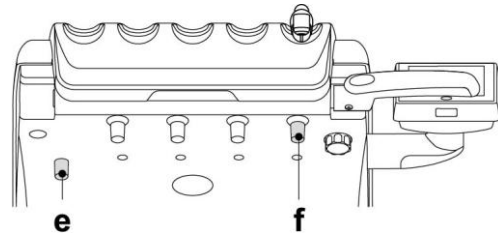

NOTE:
instrument activation is highlighted by the relevant managing screen appearing on the TOUCH DISPLAY.

- The icon buttons available on the TOUCH DISPLAY are:

- Increase of settable values.
- Decrease of settable values.
- Selection of turbine operating speed.
- Fibre optics on/off.
- Activation/deactivation independent water supply (with SANASPRAY system, only).
- Activation and selection of the type of spray delivered by the instrument.
- Main screen controls recall.
- MIN** 1% quick selection of turbine max. operating speed.
- MED** 50% quick selection of turbine max. operating speed.
- MAX** 100% quick selection of turbine max. operating speed.
- Activation/deactivation of Peristaltic pump (if installed, only).

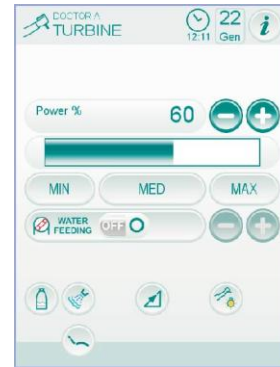

- To edit turbine rotating speed, touch icon buttons or or scroll the relevant bargraph with your finger.
- Use the foot control lever to start the instrument (see paragraph 5.2.).

NOTE:
the turbine cord can also be used to connect the air micromotors equipped with 4-way connector and conforming to ISO 13294 Standard - Dental Air Motor.

WARNING:
The instrument is supplied non-sterile.

Fibre optic brightness adjustment.

- To adjust fibre optic brightness, touch icon button (for at least 2 seconds).
- Adjust brightness level by touching icon buttons or or scrolling the bargraph with your finger.



NOTE:
value setting range: 1 to 16.

- To confirm the selected brightness, simply quit this sub-menu by touching icon button .



NOTE:
the fibre optic switches off when the instrument (foot control lever off) is not used for 30 seconds.

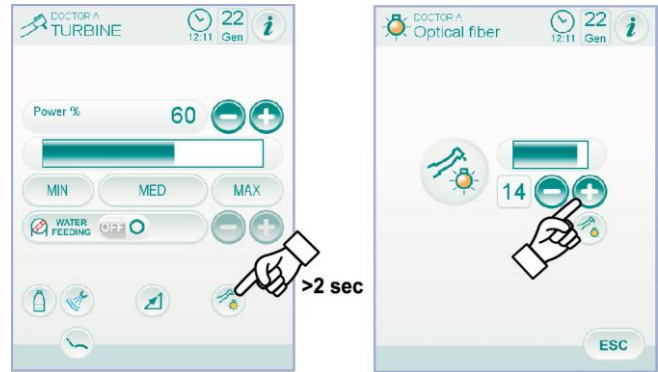

Editing turbine operating speed.

With the instrument in working position, select the turbine operating speed variation mode by touching the following icon buttons:



Linear variation, proportional to foot control lever movement.



ON/OFF variation entailing the supply of the max. power set upon foot control lever activation.

The icon corresponding to the active mode is shown on the TOUCH DISPLAY.



NOTE:
data settings are automatically saved.

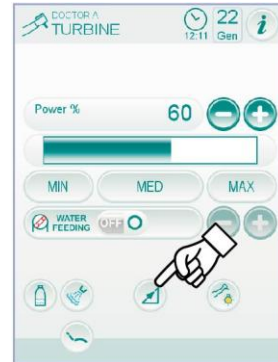

Spray to instrument control button.

With the instrument in working position, select the type of delivered spray by touching the following icon buttons:



Water + air spray operation.



Water only spray operation.



Operation without spray.

The variation is cyclical upon every touch and the icon corresponding to the active mode is shown on the TOUCH DISPLAY.



NOTE:
data settings are automatically saved.



Activation/deactivation of Peristaltic pump (if installed, only).

- To activate/deactivate peristaltic pump, simply touch the relevant icon button:



Peristaltic pump not active.



Peristaltic pump active with quantity of delivered saline solution equal to 5.



NOTE:
pump activation is confirmed by the appearance of a relevant box next to the value of delivered saline solution.

- Press icon buttons or to change the quantity of saline solution delivered by the peristaltic pump.



NOTE:
value setting range: 1 to 5. The quantity of delivered solution associated to the settable values is:

- value 1: approx. 35 cc/min,
- value 2: approx. 50 cc/min,
- value 3: approx. 70 cc/min,
- value 4: approx. 90 cc/min,
- value 5: approx. 100 cc/min.



NOTE:
the quantity of saline solution delivered by the peristaltic pump can also be edited when the instrument is active.

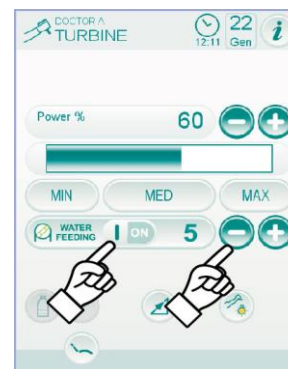

Removable cord.

The turbine features a removable cord to make cleaning operations easier (see paragraph 5.).

Cleaning and care.

Refer to the specific instructions provided with the handpiece.
It is recommended to use Daily Oil (CEFLA s.c.) for lubrication.

Disinfection.

Instrument handpiece only: see paragraph 1.5.

**WARNING:**

Carefully read the operating instructions supplied with the handpiece before attempting to sterilise.

Warnings for use.**WARNING:**

- The turbine must never be started without attaching the drill or fake drill.
- The drill release button must not be pressed down during operation!
Friction between button and micromotor impeller overheats the head and may cause burns.
- The patient's internal tissues (tongue, cheeks, lips, etc.) must be protected against contact with the button by using suitable instruments (mirrors, etc.).
- The drills and various instruments attached to the handpieces must comply with Biocompatibility Standard ISO 10993.

5.5. ELECTRIC MICROMOTOR

Coupling the handpieces and changing the drill.
Refer to the specific instructions provided with the micromotor and various handpieces.

Use.

WARNING:
Also read the instructions for use of the various motors.
The instrument is supplied non-sterile.

- **Operating times: work 5 min., rest 5 min.**
- The cock (f), found near the instrument, is used to adjust spray water quantity.
- The cock (e) adjusts the amount of air spray for all the instruments.
- Place the instrument in its work position.

NOTE:
instrument activation is highlighted by the relevant managing screen appearing on the TOUCH DISPLAY.

- The main icon buttons available on the TOUCH DISPLAY are:

- Increase of settable values.
- Decrease of settable values.
- Reduction ratio selection.
- Reduction ratio selection.
- Selection of turbine operating speed.
- Selection of micromotor drill rotation direction.
- Activation/deactivation of alarm signal.
- Reduction ratio setting (see paragraph 5.5.4.).
- Fiber optics on/off.
- Activation/deactivation independent water supply (with SANASPRAY system, only).

- Use the foot control pedal to start the instrument (see paragraph 5.).

Fiber optic brightness adjustment.

- To adjust fiber optic brightness, touch icon button (for at least 2 seconds).
- Adjust brightness level by touching icon buttons or or scrolling the bargraph with your finger.

NOTE:
value setting range: 1 to 16.

- To confirm the selected brightness, simply quit this sub-menu by touching icon button .

NOTE:
the fiber optic switches off when the instrument (foot control lever off) is not used for 30 seconds.

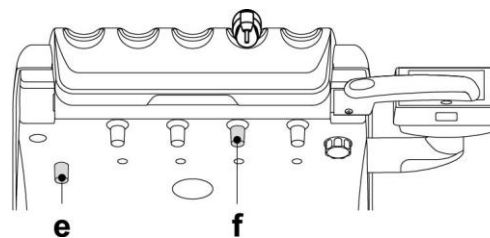

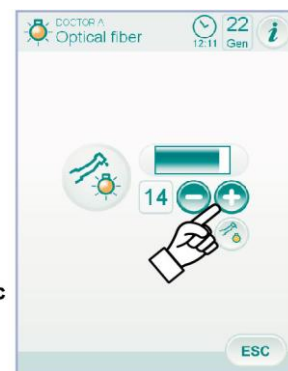
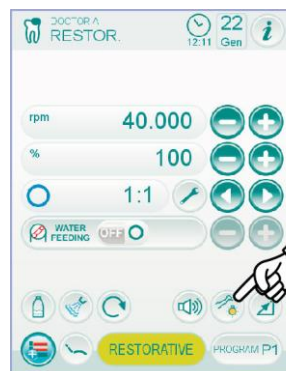

- Activation and selection of the type of spray delivered by the instrument.
- Main screen controls recall.
- Simplified menu display.
- Activation/deactivation of peristaltic pump (if installed, only).
- Micromotor operating mode selection.
- Micromotor working programme selection.



Spray to instrument control button.

With the instrument in working position, select the type of delivered spray by touching the following icon buttons:



-  Water + air spray operation.
-  Water only spray operation.
-  Operation without spray.

The variation is cyclical upon every touch and the icon corresponding to the active mode is shown on the TOUCH DISPLAY.

 **NOTE:**
the data set are automatically saved.

Rotating speed editing mode selection.

With the instrument in working position, select the rotating speed editing mode by touching the following icon buttons:



-  Linear variation, proportional to foot control lever movement.
-  ON/OFF variation entailing the supply of the max. power set upon foot control lever activation.

The icon corresponding to the active mode is shown on the TOUCH DISPLAY.

 **NOTE:**
data are automatically saved.

Reversing micromotor drill rotation direction.

Select micromotor drill rotation direction by touching the relevant icon button:

-  Standard rotation direction.
-  Reversed rotation direction.





Reversed rotation direction is signalled by a sound (3 BEEPS).

 **WARNING:**
As soon as the micromotor is extracted, a sound (3 BEEPS) warns the operator if the direction of rotation is reversed.

 **NOTE:**
when the rheostat lever is on, the micromotor drill cannot reverse its direction of rotation.

Micromotor operating mode selection.

The micromotor has 4 different operating modes that can be selected by touching the relevant icon button:

-  RESTORATIVE mode (see paragraph 5.5.1.).
-  ENDODONTIC mode (see paragraph 5.5.2.).
-  IMPLANT mode (see paragraph 5.5.3.).
-  RECIPROCATING mode (optional) (see paragraph 5.5.5.).

 **NOTE:**
the variation is cyclical.



Micromotor working programme selection.

The micromotor has 7 different working programmes that can be selected by touching the relevant icon button.

NOTE: keep icon button pressed (for at least 2 seconds) to display a screen showing all the 7 available programmes.

Each working programme saves the following data:

- operating mode,
- max. rotating speed / torque value,
- fiber optic on/off,
- fiber optic brightness,
- rotation direction reversal on/off,
- type of delivered spray,
- peristaltic pump on/off (if installed),
- handpiece reduction ratio.

Reduction ratio selection.

Use icon buttons or to select the desired reduction ratio among the available ones.

The torque value (set or current) is expressed in % or Ncm for certified reducers.

WARNING:

An icon identifying the reading tolerance on the indicated value is shown close to the torque value:

5,0 ±10% tolerance

5,5 ±20% tolerance.

NOTE: the data set are automatically saved.

Activation/deactivation of alarm signal.

To activate/deactivate an alarm signal once max. torque set value is reached, simply touch the relevant icon button:

Alarm active.

Alarm not active.

NOTE: data are automatically saved.

Activation/deactivation of Peristaltic pump (if installed, only).

To activate/deactivate peristaltic pump, simply touch the relevant icon button:

Peristaltic pump not active.

Peristaltic pump active with quantity of delivered saline solution equal to 5.

NOTE: pump activation is confirmed by the appearance of a relevant box next to the value of delivered saline solution.

Press icon buttons or to change the quantity of saline solution delivered by the peristaltic pump.

NOTE: value setting range: 1 to 5. The quantity of solution delivered associated to the settable values is:

- value 1: approx. 35 cc/min,
- value 2: approx. 50 cc/min,
- value 3: approx. 70 cc/min,
- value 4: approx. 90 cc/min,
- value 5: approx. 100 cc/min.

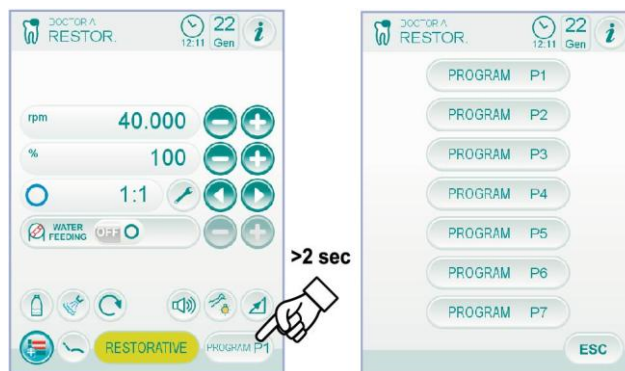



NOTE:

the quantity of saline solution delivered by the peristaltic pump can also be edited when the instrument is active.

Removable hose.

The micromotor features a removable hose to make cleaning operations easier (see paragraph 5.).

Cleaning and maintenance.

Refer to the specific instructions provided with the instrument.

It is recommended to use Daily Oil (CEFLA s.c.) for lubrication.



WARNING:

- Do not soak the instrument in disinfectant fluids or detergents.
- Inadvisable products: abrasive products and/or products containing acetone, chlorine and sodium hypochlorite.

Sterilization.

Instrument handpiece only: see paragraph 1.5.



WARNING:

Carefully read the operating instructions supplied with the instrument before attempting to sterilise.

Warnings for use.



WARNING:

- Never put the contra angle on the micromotor while it is running.
- The drill release button must not be pressed during operation!
Friction between the button and micromotor rotor overheats the head and may cause burns.
- The patient's internal tissues (tongue, cheeks, lips, etc.) must be protected against contact with the button by using suitable instruments (mirrors, etc.).
- The drills and various instruments attached to the handpieces must comply with Biocompatibility Standard ISO 10993.

5.5.1. RESTORATIVE OPERATING MODE

Characteristics.

- speed range: 100 to 40,000 Rpm (1:1 handpiece),
- speed range: 1 to 100%,
- reduction ratio customizable list,
- rotation speed editing mode, from fixed to variable and vice versa,
- alarm signal upon reaching the maximum set torque,
- quick reading of max. speed during motor rotation.

Menu with micromotor extracted but not active.

All icon buttons are active and all available functions can be edited (see paragraph 5.5.).

NOTE:
any edited setting or value will be automatically saved inside the selected working programme (ex. P1).

Menu with micromotor extracted and active.

The following functions can be changed:

- drill max. rotation speed using icon buttons or ,
- current speed can be frozen with the following icon button:

It sets current rotating speed as max. speed.

- foot control lever editing mode with the following icon buttons:

It sets current rotating speed as max. speed by enabling, at the same time, an ON/OFF editing mode of the foot control lever.

It brings foot control lever editing mode from ON/OFF to linear.



5.5.2. ENDODONTIC OPERATING MODE

Characteristics.

- speed value adjustable from 100 to 1200 Rpm with value always referring to the drill, regardless the reduction ratio,
- torque value adjustable from 0.1 to 5.0 Ncm, 1:1 reducer excluded (4.5 Ncm),
- reduction ratio customizable list,
- customizable list for root canal drills,
- motor rotation speed editing mode, from fixed to variable and vice versa,
- progressive alarm signal starting from 60% of maximum set torque,
- setting button during motor rotation.

Menu with micromotor extracted but not active.

All icon buttons are active and all available functions can be edited (see paragraph 5.5).

Besides the standard settings, in the ENDODONTIC mode it is also possible to adjust the following functions:

NOTE:
any edited setting or value will be automatically saved inside the selected working programme (ex. P1).

• **Operation at maximum set torque.**



Rotation lock.



Rotation lock followed by rotation direction reversal.



Rotation lock, reversal of standard direction of rotation followed by the recovery of the standard direction of rotation.



• **Customizable list for root canal drills control.**

- Press icon buttons or to scroll the list of pre-set root canal drills.

As soon as the new drill is selected, the corresponding speed and torque values will be automatically set.

- By pressing the box relating to the set drill, the page showing the list of all available drills can be accessed.

Here you can scroll the list, selecting the desired drill, or create customized drills (see paragraph 5.5.2.1.).

If speed and torque values are edited (compared to those set in the list), the box background will turn yellow to warn the dentist that the values recommended by the manufacturer are NOT being used.

If the box relating to the set drill is pressed when the background is YELLOW the optimal values inside the list will be set again, and the background will turn into the standard colour.

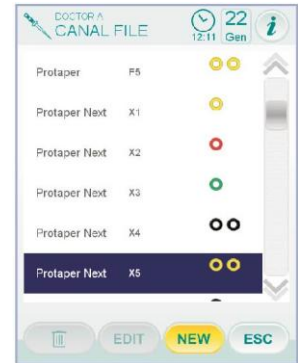

• **Certified contra angle pre-set list.**

- By pressing icon buttons or it is possible to scroll the list of the certified contra-angles:

Display text	Ratio	Display torque	Torque tolerance to drill	Reference contra angles
128:1	128:1	100%	±20%	All makes
120:1	120:1	100%	±20%	All makes
64:1	64:1	100%	±20%	All makes
40:1	40:1	100%	±20%	All makes
18:1	18:1	100%	±20%	All makes
16:1	16:1	5 Ncm	±20%	All makes
E16	16:1	5 Ncm	±10%	Castellini E16®
EVO E16	16:1	5 Ncm	±10%	Goldspeed EVO E16®
10:1	10:1	5 Ncm	±20%	All makes
ER10	10:1	5 Ncm	±10%	NSK ER10®
9.5:1	9.5:1	5 Ncm	±20%	All makes
S6:1	6:1	5 Ncm	±10%	Sirona Endo 6:1
K5.4:1	5.4:1	5 Ncm	±10%	Kavo IntraC 0767 LHC®
4:1	4:1	5 Ncm	±20%	All makes
ER4	4:1	5 Ncm	±10%	NSK ER4®
K2.7:1	2.7:1	5 Ncm	±10%	Kavo LUX 7LP® Kavo IntraC 0768 LHC®
WD-79M	2:1	5 Ncm	±10%	W&H WD-79M® W&H EB-79M®
1:1	1:1	4.5Ncm	±10%	All makes



- Touch icon button to edit the reduction ratio (see paragraph 5.5.4.).

Menu with micromotor extracted and active.

The following functions can be changed:

- drill max. rotation speed using icon buttons or ,
- handpiece calibration using the following icon button:



It sets current set torque to 0.



NOTE:

we recommend carrying out this operation while the handpiece is working at max. speed and with no load.

- foot control lever editing mode with the following icon buttons:



It sets current rotating speed as max. speed by enabling, at the same time, an ON/OFF editing mode of the foot control lever.



It brings foot control lever editing mode from ON/OFF to linear.



5.5.2.1. ROOT CANAL DRILL CUSTOMIZATION MENU

From the extracted but not active micromotor menu, touch the box relating to the set drill to access the page showing the list of all available root canal drills and having the following icon buttons:



Delete customized drill.



Edit customized drill.



Create customized drill.



Quit the menu and save settings.

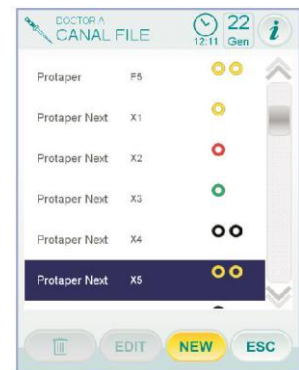
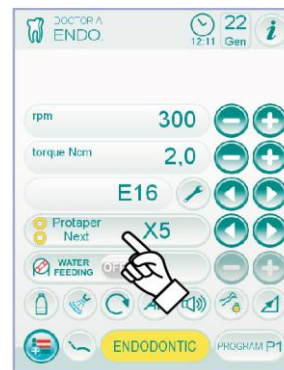

Customized drill creation.

To create one or more root canal drills, simply touch icon button to access the EDITING screen:

- touch icon button to enter the name or code of the customized drill,
- touch icon buttons or to increase or reduce the speed or torque value you want to associate to the customized drill,
- touch icon buttons or to select the colours of the rings relating to the customized drill,
- to confirm entered data, simply quit the EDITING screen by touching icon button .

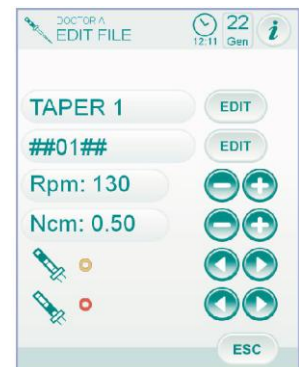
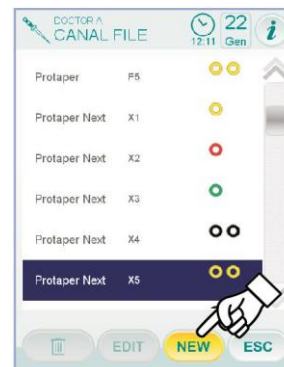

Editing and/or cancelling of customized drill.



NOTE:

only customized drills can be edited and/or cancelled.

- select the customized drill you wish to edit or cancel,
- touch icon button to access the EDITING screen and edit drill data,
- touch icon button to cancel the customized drill.

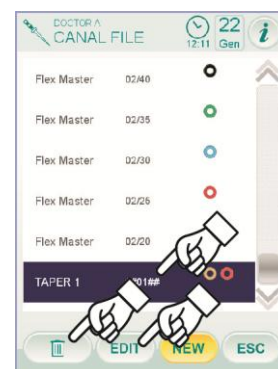

5.5.3. IMPLANT OPERATING MODE

Characteristics.

- speed value adjustable from 5 to 2500 Rpm with value always referring to drill, regardless of reduction ratio (reducers from 20:1 to 1000:1),
- torque adjusting range; 0.5 to 55.0 Ncm for certified reducers, or 1 to 100%,
- reduction ratio customizable list,
- alarm signal upon reaching the maximum set torque,
- setting button during motor rotation.

Menu with micromotor extracted but not active.

All icon buttons are active and all available functions can be edited (see paragraph 5.5.).

NOTE: any edited setting or value will be automatically saved inside the selected working programme (ex. P1).



Hereinafter is the list of the acronyms of the types of certified contra angles indicated on the TOUCH DISPLAY:

Display text	Ratio	Display torque	Torque tolerance to drill	Reference contra angles
1000:1	1000:1	50 Ncm	⚠️ ±20%	All makes
256:1	256:1	50 Ncm	⚠️ ±20%	All makes
120:1	120:1	50 Ncm	⚠️ ±20%	All makes
ATR80I	80:1	70 Ncm	±10%	ATR ATR80I®
ER64	64:1	55 Ncm	±10%	NSK SGM-ER64i®
ER32	32:1	55 Ncm	±10%	NSK SGM-ER32i®
K27:1	27:1	55 Ncm	±10%	Kavo IntraLux CL09® + Testina CL3®
20:1	20:1	50 Ncm	⚠️ ±20%	All makes
75EKM	20:1	55 Ncm	±10%	W&H WI-75E/KM® W&H WS-75E/KM®
R20L	20:1	55 Ncm	±10%	Castellini R20L® NSK X-SG20L® NSK S-Max SG20® NSK SGM ER20i®
ATR20I	20:1	70 Ncm	±10%	ATR ATR20I®
WS75	20:1	70 Ncm	±10%	W&H WS-75® W&H WI-75E/KM®
CA20L	20:1	55 Ncm	±10%	Bien-Air CA20:1L®
16:1	16:1		±10%	All makes
K12:1	12:1	40 Ncm	±10%	Kavo IntraLux CL04®+ Testina CL3®

Menu with micromotor extracted and active.

The following functions can be changed:

- drill max. rotation speed using icon buttons or ,
- handpiece calibration using the following icon button:

CAL It sets current set torque to 0.

NOTE: we recommend carrying out this operation while the handpiece is working at max. speed and with no load.



• foot control lever editing mode with the following icon buttons:



It sets current rotating speed as max. speed by enabling, at the same time, an ON/OFF editing mode of the foot control lever.



It brings foot control lever editing mode from ON/OFF to linear.

5.5.4. REDUCTION RATIO SETTING MENU

From the menu of the extracted but not active micromotor, touch the icon button or access the REDUCTION RATIO SETTING sub-menu including the following icon buttons:



Reduction ratio selection saved.



Quit the menu and save selected ratio.



Create a customized reduction ratio.



Edit a customized reduction ratio.

NOTE:

the Rpm icon field cannot be edited as it only displays the max. speed that can be reached with the selected reduction ratio.

How to create customized reduction ratios.

To create and save customized reduction ratios, simply touch icon button



to access the relevant sub-menu with the following icon buttons:



Tenths or units increase/reduction.



Save created/edited ratio.



Recall default reduction ratio.



Delete customized reduction ratio.

How to edit and/or delete customized reduction ratios.

NOTE:

only customized reduction ratios can be edited and/or deleted.

- Touch icon buttons or to scroll the saved reduction ratios.
- After having selected the reduction ratio, touch icon button to access the editing sub-menu.
- The editing sub-menu works exactly like the creation sub-menu.

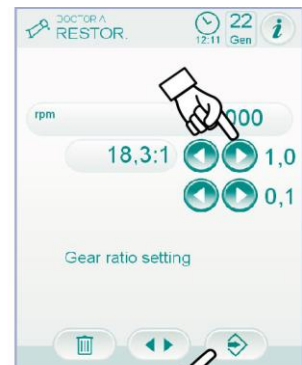
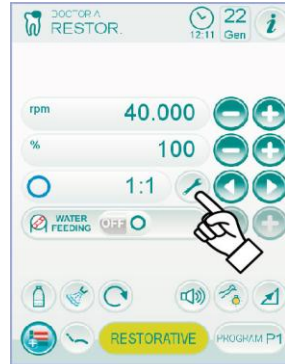

5.5.5. RECIPROCATING OPERATING MODE

Characteristics.

- 2 selectable reduction ratios: 4:1 and 6:1,
- 3 selectable root canal drills,
- progressive alarm signal starting from 60% of maximum set torque,

Menu with micromotor extracted but not active.

All icon buttons are active and all available functions can be edited (see paragraph 5.5.).

In addition to the standard settings, the RECIPROCATING mode also allows adjusting the following functions:

• Reversing micromotor drill rotation direction.

Select micromotor drill rotation direction by touching the relevant icon button:



Standard rotation direction: rotation with reciprocating motion.



Reversed rotation direction: counter clockwise rotation with continuous movement (helps releasing the drill from the root canal).

Reversed rotation direction is signalled by a sound (3 BEEPS).



WARNING:

As soon as the micromotor is extracted, a sound (3 BEEPS) warns the operator if the direction of rotation is reversed.

• Operation at maximum set torque.





Rotation lock.



Rotation lock followed by rotation direction reversal.

• List of root canal drills.



Press icon buttons  or  to scroll the list of pre-set root canal drills:

- Waveone® Gold ^[1],
- Reciproc® ^[2],
- Reciproc® Blue ^[2].

^[1] WAVE ONE® is a registered trademark of DENTSPLY SIRONA INC., York, Pennsylvania, USA.

^[2] RECIPROC® is a registered trademark of VDW GmbH, München, Germany.

• Certified contra angle pre-set list.

Press icon buttons  or  to scroll the list of the certified contra angles:

Display text	Ratio	Reference contra angles
EVO E4	4:1	Goldspeed EVO E4®
S6:1	6:1	Sirona Endo 6:1



Menu with micromotor extracted and active.

The only active icon button is the activation/deactivation of the alarm signal upon reaching the maximum set torque.



5.6. SCALER

Connecting the handpiece and insert.
Refer to the specific instructions provided with the handpiece.

WARNING:
Before attempting to connect the handpiece, make sure the contacts are perfectly dry. Blow air from the syringe, if necessary, to dry.

Warnings for use.

WARNING:

- Make sure the threaded sections of the inserts and handpiece are perfectly clean.
- Do not change the shape of the insert.
- Check wear and tear of the insert on a regular basis, replacing it in the following cases:
 - obvious wear,
 - drop in performance,
 - deformation or impact.
- Notes for U-PZ7 scalers:
 - Class 1 LED device;
 - do not direct the light beam to anyone's eyes when cleaning or servicing the device (it is recommended to keep the fibre optics switched off).

Use.

- Operating times: see operating instructions supplied with the handpiece.
- The cock [f], found near the instrument, is used to adjust the cooling water flow.
- Place the instrument in its working position.

NOTE:
instrument activation is highlighted by the relevant managing screen appearing on the TOUCH DISPLAY.

- The icon buttons available on the TOUCH DISPLAY are:

- Increase of settable values.
- Decrease of settable values.
- Selection of scaler power variation mode.
- Fibre optics on/off.
- Activation/deactivation of independent water supply (with S.H.S. system only).
- Enabling of cooling water.
- Main screen controls recall.

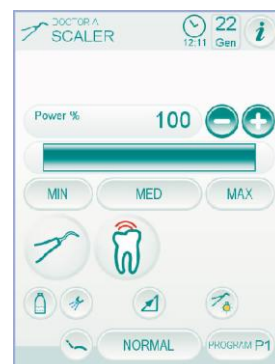
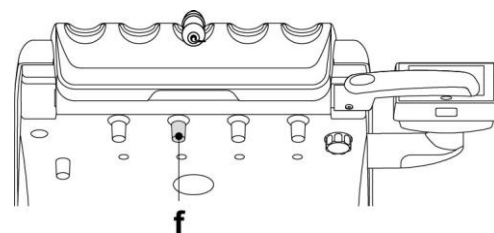

NORMAL

Scaler operating mode selection.

PROGRAM P1

Scaler working programme selection.

- To adjust scaler power, touch icon buttons or or scroll the bargraph with your finger.
- Use the foot control lever to start the instrument (see paragraph 5.2.).



WARNING:

The instrument is supplied non-sterile.

Fiber optic brightness adjustment.

- To adjust fiber optic brightness, touch the icon button (for at least 2 seconds).
- Adjust brightness level by touching icon buttons or scrolling the bargraph with your finger.



NOTE:

value setting range: 1 to 16.

- To confirm the selected brightness, simply quit this sub-menu by touching icon button.



NOTE:

the fiber optic switch off when the instrument (foot control lever off) is not used for 30 seconds.

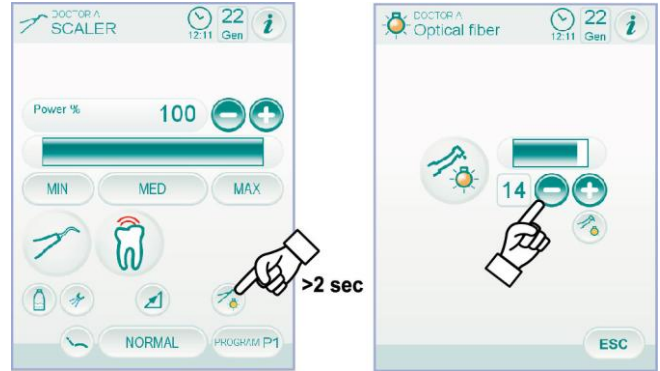

Selection of scaler power variation mode.

With the instrument in working position, select the scaler power editing mode by touching the following icon buttons:



Linear variation, proportional to foot control lever movement.



ON/OFF variation entailing the supply of the max. power set upon foot control lever activation.

The icon corresponding to the active mode is shown on the TOUCH DISPLAY.



NOTE:

the data set are automatically saved.



Enabling of cooling water.

With the instrument in working position, select whether to deliver water or not to the instrument by touching the following icon buttons:



Operation with water.



Operation without water.

The variation is cyclical upon every touch and the icon corresponding to the active mode is shown on the TOUCH DISPLAY.



NOTE:

during operation without water, the max. delivered power corresponds to 50% of the max. settable power.



NOTE:

the data set are automatically saved.



Scaler operating mode selection.

With the instrument in working position, select the scaler operating mode by touching the following icon buttons:

- NORMAL** Standard operating mode.
- ENDO** ENDO operating mode.
- PARO** PARO operating mode (ENDO with power reduced by 40%).

The variation is cyclical upon every touch and the icon corresponding to the active mode is shown on the TOUCH DISPLAY.

NOTE:
with the foot control lever activated, you cannot edit operating mode.

NOTE:
the data set are automatically saved.

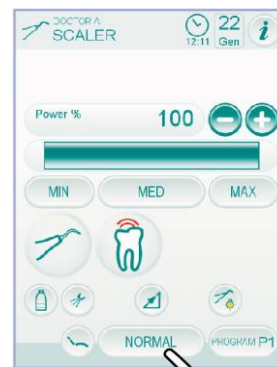

Scaler working programme selection.

The scaler has 4 different working programmes, identified with P1, P2, P3 and P4, that can be selected by touching the relevant icon button.

Each working programme saves the following data:

- maximum power,
- fiber optic on/off,
- fiber optic brightness,
- type of delivered spray,
- power variation mode.

NOTE:
the variation is cyclical.

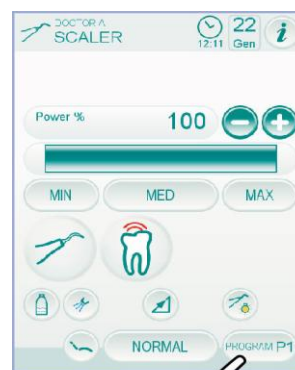

Removable hose.

The scaler features a removable hose to make cleaning operations easier (see paragraph 5.).

Cleaning and maintenance.

Refer to the specific instructions provided with the instrument.

WARNING:
• Do not soak the handpiece in disinfectant liquids or detergents.

Sterilization.

- Torque wrench, scaler bits and scaler handpiece: steam autoclave up to 135°C following the instructions for the use of the device.

WARNING:
Carefully read the operating instructions supplied with the instrument before attempting to sterilise.

Safety standards.

WARNING:

- To avoid hazards or malfunctions when connecting the board, do not reverse the positions of the hoses for scalers of different brands.
- The inserts fitted on the handpiece must be in compliance with Biocompatibility Standard ISO 10993.

5.7. T LED CURING LIGHT

Technical specifications.

Supply voltage: 24-36 VDC

Max. power absorbed: 6 VA

Light source: 1 5W LED

Wavelength: 430-490 nm

Acoustic signals: at cycle start, every 5 seconds, and at cycle end

Type of operation: intermittent (work 3 consecutive cycles - rest 60 sec.)

Programs: 6 (preset).

General description of the lamp.

a Lamp handpiece.

b Rotary end.

c Fiber optic.

d Eye protection.

e Power cord.

f Control console.

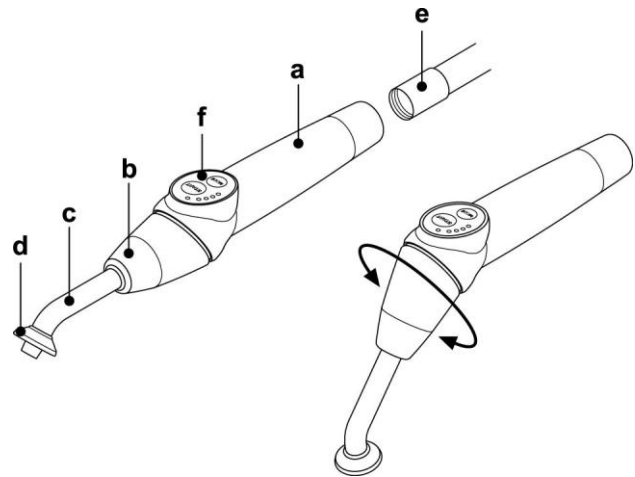

NOTE:

the curing light can be used in different configurations (wand-style, gun-style or any intermediate position) as it is more convenient for the user.



NOTE:

the curing light is delivered in its original packing which should be kept for future shipment.

Description of the control pad.

1 LED 1 (STANDARD cycle) :

Emission of 1000 mW/cu.cm for 20 seconds (this cycle is set as default at the time of sale).

2 LED 2 (FAST cycle) :

Emission of 1600 mW/cu.cm for 15 seconds.

3 LED 3 (STRONG cycle) :

Emission of 1800 mW/cu.cm for 20 seconds.

4 LED S :

When LED S is on, you access ramp cycle mode and at the same time the LEDs B, R and L next to it come on:

[LED S + LED 1] ramp cycle B (BONDING) :

Ramp cycle with emission of 500 mW/cu.cm for 5 seconds, ramp from 500 to 1000 mW/cu.cm for 5 seconds and 1000 mW/cu.cm for 5 seconds for a total of 15 seconds.

[LED S + LED 2] ramp cycle R (RAPID RESTORATION) :

Ramp cycle with emission of 500 mW/cu.cm for 5 seconds, ramp from 500 to 2200 mW/cu.cm for 5 seconds and 2200 mW/cu.cm for 5 seconds for a total of 15 seconds.

[LED S + LED 3] ramp cycle L (LONG RESTORATION) :

Ramp cycle with emission of 500 mW/cu.cm for 5 seconds, ramp from 500 to 1800 mW/cu.cm for 5 seconds and 1800 mW/cu.cm for 10 seconds for a total of 20 seconds.

5 Malfunction signalling LED :

This red LED comes on only if there is a malfunction.

6 START button :

Pressing the START button starts the cycle currently selected (the cycle LED will come on).

If it is pressed again at any time during the cycle, light beam emission will immediately be interrupted.

7 MODE button :

This button is used to select the cycle to be run. It allows changing from the current cycle to the immediately following cycle.

The first three cycles (1, 2 and 3) are at constant power and the LEDs come on individually. When LED S is on, you access ramp cycle mode and at the same time the LEDs B, R and L come on.

Once the LED of the cycle you intend to use has come on, the lamp is ready for use. Pressing the START button, light beam emission is activated according to the selected cycle.



NOTE:

the cycle can be selected and the button is operative only when the curing light is not emitting any light. If the button is accidentally pressed while light is being emitted, nothing will happen.

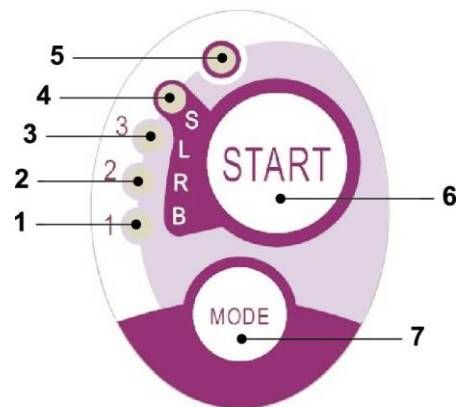

Cycle	LED	Total time	Ø8 mm	Total energy
STANDARD	1	20"	1,000 mW/cm ²	20,000 mJ
FAST	2	15"	1,600 mW/cm ²	24,000 mJ
STRONG	3	20"	1,800 mW/cm ²	36,000 mJ
BONDING	S+1	15"	ramp cycle	11,250 mJ
RAPID REST.	S+2	15"	ramp cycle	20,250 mJ
LONG REST.	S+3	20"	ramp cycle	26,250 mJ

Operation.

WARNING:
The instrument is supplied non-sterile.

Before use, disinfect the lamp grip. The fiber optic and the eye protection can be sterilised in a steam autoclave up to 135°C.

- Put the fiber optic (**c**) in its housing until it clicks.
- Attach the curing light handpiece to the end of its power hose and tighten the ring nut (**e**).
- Take the lamp out of its housing on the assistant's board or dentist's board.

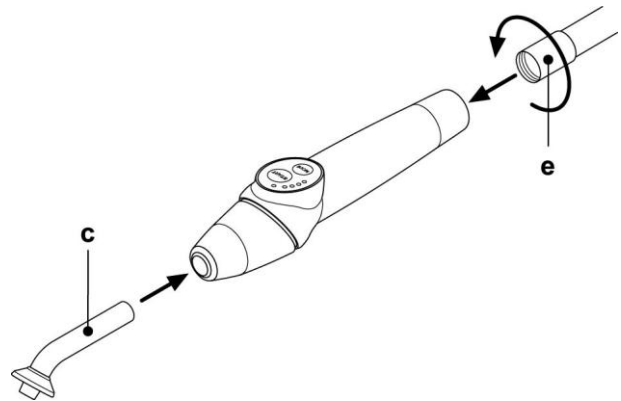

NOTE:
instrument activation is highlighted by the relevant managing icon appearing on the TOUCH DISPLAY.

- Turn the front of the lamp and/or fiber optics to the position most suitable for curing (wand, gun or intermediate position).
- Use the MODE button to select the desired cycle as previously directed (the selected cycle is always indicated by the illuminated LED).

NOTE:
the curing light has a permanent memory therefore the last cycle used will always be present the next time it is used.

- Place the fiber optics in the position required for curing.

NOTE:
the fiber optics should be placed as close as possible to the material to be cured without touching it.

- Press button START to start the cycle.

WARNING:
Operating mode: work 2 consecutive cycles, rest 60 seconds.

NOTE:
when a programmed cycle is activated, the LEDs (1, 2, 3, B, R, L) indicate the time that elapses (in multiples of 5 seconds) and turn off every 5 seconds of operation. The curing light comes with a beep that BEEPS when the cycle starts, BEEPS every 5 seconds of operation and lastly BEEPS twice at the end of the work cycle.

- Allow light emission to stop by itself. However, it can be stopped at any time by simply pressing the START button again.

WARNING:

- The curing light is equipped with a system that signals malfunctions by illuminating the LEDS in different combinations (see next paragraph).
- The curing light is equipped with a cut-out.

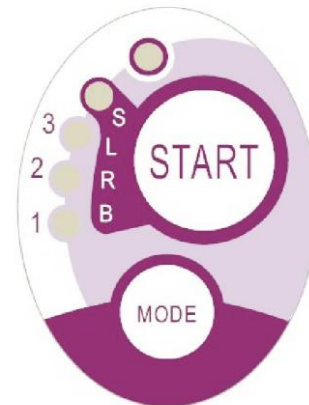

Indicators.

The following indicators are provided on the control console to signal curing light fault:

- **LED 5 and LED 1, green, steady on.**
Lamp does not emit any light.
Contact technical service department.
- **LED 5 and LED 2, green, steady on.**
Instrument start up microcontroller fault.
Contact technical service department.
- **LED 5 and LED 3, green, steady on.**
Power supply too low.
Contact technical service department.
- **LED 5 and LED 4 flash continuously.**
Handpiece cut-out tripped. These LEDs will continue to flash until the light has cooled down enough (about 5 minutes) to be used again.
If the problem persists, contact technical service department.

Maximum curing thickness.

The maximum curing thickness with every single cycle is 3 millimetres (refer to the instructions of the composite material used as well).



WARNING:

This thickness must not be exceeded as the layer may not be completely cured.

Warnings for use.



WARNING:

The LED is a Class 2 light source in accordance with IEC 62471 standard. **DO NOT STARE AT THE BEAM.**

The light emitted may cause eye injury in case of direct radiation without eye protection.

Always use an eye protection shield when operating the curing light and do not direct the light beam to the eyes.

The light emitted may damage soft tissues (oral cavity mucous membrane, gums, skin).

Be extremely careful to aim the light precisely on the material to be cured.

- **People with eye diseases, such as those who have had cataracts removed or retina diseases must be adequately protected when the curing light is used, for example with suitable protective eyewear.**
- **The rotary end can turn 180° counter-clockwise in relation to the handpiece to change from wand to gun configuration.**
To go back to wand configuration, turn clockwise.
A click is heard when these two positions are reached. Do not turn any more once the click is heard.
The intermediate positions can be used even if a click is not heard.
Put the fiber optics back into the correct position after turning the end section.
- **Do not pull the power cord.**
- **Do not expose the handpiece to excessive vibrations.**
- **Do not drop the handpiece and in particular the fiber optics.**
The lamp may break if accidentally banged.
Check the condition of the handpiece if it has been banged or dropped before using the curing light.
Try to turn on the light and check operation first without using it on the patient.
If cracked, broken or if there are any other faults, do not use the curing light on the patient and contact the technical service department.
The fiber optics is rather delicate and may crack or break if banged, affecting the final amount of light emitted.
If dropped, carefully inspect the fiber optics to verify if it is cracked or broken. If cracked, a strong light appears in the spot in which the fiber is cracked.
In all these cases, the fiber optics must be replaced.
- **The curing light handpiece (sold separately) can be connected only to dental units with connections for this curing light handpiece. Connection to any other equipment may damage the circuits inside the lamp and seriously injure the user and patient.**
- **The curing lamp handpiece is not protected against liquid penetration.**
- **The curing lamp handpiece is not suitable for use in the presence of flammable anaesthetic gas mixed with air, oxygen or nitrous oxide (N₂O).**

Cleaning.

The curing light may be a means of cross contamination between patients.

The most contaminated parts are the fiber optics and the eye protection. Before sterilising them, make sure there are no residues of curing products: if necessary, clean with alcohol or a plastic spatula.

Exclusively sterilise the optical fibre and the eye protection in an autoclave at a sterilisation temperature of at least 134°C.



WARNING:

- **The fiber optics can undergo 500 autoclave cycles after which it tends to become opaque and therefore emit less light.**
- **The eye protection must also be replaced after 500 cycles.**
- **Contact the manufacturer to purchase original spare parts (fiber optics + eye protection: code 97660404).**

The handpiece cannot be put in autoclave; disinfect it on the outside with suitable products and cover it with disposable plastic wrap.

Use soft disposable paper towels to disinfect the handpiece. Do not use harsh products or soak in liquids.



WARNING:

- **The curing light handpiece is NOT suitable for autoclave.**
- **The curing light handpiece is not protected against penetration of liquids therefore it CANNOT be soaked in a solution to be sterilized.**
- **The outside of the lamp should be disinfected with the fiber optics on.**
Do not use any type of disinfectant on the exposed optical surface of the handpiece when the fiber is removed. The surface will become irreparably opaque if it comes into contact with disinfectant.

Maintenance.

This equipment does not require any particular type of maintenance.

Only technicians authorised by the manufacturer can replace and/or repair the handpiece and dental unit.

The handpiece has been purposely constructed in a manner that requires specific tools to open it and therefore it cannot be removed by the user.

The warranty is automatically void if the handpiece is altered in any way.

Troubleshooting.**• When the lamp is removed, the light does not come on (no LED on control console illuminated).**

Make sure the Midwest connection is correctly attached to the power cord.

Carefully screw the ring nut, try to put the lamp back in and then take it out again.

If the problem persists, contact technical service department.

• Less light emitted.

- Make sure the fiber optics is not cracked or damaged in any way: replace it if it is so.

 Contact the manufacturer to purchase original spare parts.

- Make sure there are no residues of curing products on the end of the fiber optics: if necessary, wipe off with alcohol or a plastic spatula.

If the handpiece must be sent back, please disinfect it.

Ship it back in its original packing.

In addition, please enclose a description of the fault with the shipping note.

5.8. C-U2 DENTAL CAMERA

The C-U2 dental camera system, complete with an extremely lightweight ergonomic handpiece, is specially designed for simple and well-conceived usability in examining the oral cavity. Auto-exposure and fixed focus features provide easy operation. This system is designed to allow the dentist to more efficiently show and explain to patients all oral conditions and reasons for planned treatment. The C-U2 system allows taking high-definition (1280x720) live images of the section in question through the touch of a fingertip on the touch-sensitive area of the handpiece. The live intraoral images are displayed on the monitor or Personal Computer.

-  **WARNING:**
The camera may be used as a tool to aid in diagnosis; however, the result must always be supported with visual examination and/or other diagnostic indications.
Evaluations and conclusions based only on the image taken by the camera may be poor as the colours and shapes, electronically processed, may not perfectly correspond to the actual ones.

Warnings for use.

-  **WARNING:**
- The external PC and the external monitor must be of medical grade, namely they have to be certified and comply with the standard IEC 60601-1 3rd Ed. They have to be able to ensure a double insulation level for both patient (2 MOPP) and operator (2 MOOP): - with respect to the power mains; - to all the I/O ports (USB, LAN) supplied with Safety Extra Low Voltage (SELV).
 - Even though the electromagnetic field irradiated by the device is insignificant, it is advisable not to use it in proximity of life support equipment (e.g. pacemakers or heart stimulators) according to the specifications included in the user manual of such equipment.
 - The disposable infection control sheaths must be used with the device. Change the sheath for each new patient.
 - After putting on a new disposable infection control sheath, check it over before using the camera, making sure it is not torn anywhere. If it is, take it off and put on a new one.
 - Do not place the handpiece in liquids or in autoclave under any circumstances.
 - Store the handpiece in a clean dry area.
 - Do not bend the connecting cable excessively.
 - Be extremely careful not to drop the handpiece and do not expose it to excessive vibrations.
 - Never use a damaged handpiece. Make sure the camera is in good condition and has no sharp edges before attempting to use it. If in doubt, do not use the handpiece, carefully put it away, and contact technical assistance.
 - Before starting the equipment, check the condition of the lens protection.
 - Do not aim the light beam at the operator's or patient's eyes during operation.
 - During continuous use (example, more than 10 consecutive minutes), the temperature of the camera's tip usually increases significantly; if this is uncomfortable, put the handpiece in its holder for a few minutes to allow the light source to cool down. When the camera needs to be used for a prolonged time, reduce light brightness using the cursor on the OSD Control Panel (see paragraph 5.8.1.).
 - If left running for extended periods, make sure the temperature of the tip is acceptable before attempting to use the camera. Briefly touch the clear plastic part with your fingertip being careful not to touch the lens in the middle.
 - Do not attempt to bend, pull or remove the handpiece.

Connecting the handpiece.

Attach the handpiece of camera C-U2 (**a**) to the end of the cord and tighten the ring nut (**b**).

-  **WARNING:**
Make sure the cord is firmly screwed onto the handpiece.

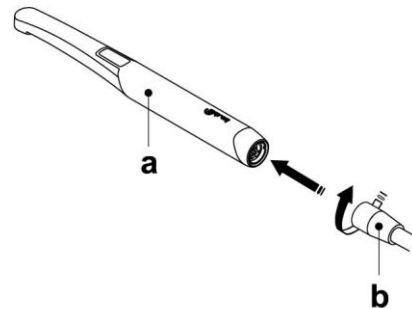





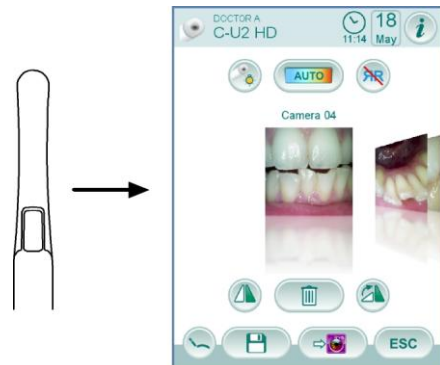







Use of the camera.

- Place the instrument in its working position.
 Now camera is activated and is in LIVE mode (monitor shows "moving" images) or FREEZE mode (monitor shows a snapshot).







• The main icon buttons available on the TOUCH DISPLAY are:

- 
Colour profile adjustment
(only with camera extracted and set to LIVE).
- 
Camera LED turning on/off
(only with camera extracted).
- 
Activation/deactivation of MIRROR function
(only with camera extracted and set to LIVE).
- 
Overturn the captured image.
- 
Turn captured image clockwise.
- 
Recall main controls of main screen.
- 
Delete the captured image.
- 
Move the captured images to a folder of the internal memory or USB (only with camera in rest position).
- 
Move the captured images to an iRYS folder
(only with camera in rest position and PC connected to IRYS).
- 
Move the captured images to the PC (only with camera in rest position and PC connected to iCapture).
- 
Go back to the main screen without moving the captured images.

- Shortly press the touch key on camera handpiece or operate the foot control to capture the image shown on the monitor.
To go back to "live" image, simply touch again the touch key on camera handpiece or operate again the foot control.
- When camera is put back in place, the screen with captured images is still shown on the TOUCH DISPLAY; to go back to main screen, simply touch icon button  .

Camera LED brightness adjustment.

- To adjust camera LED brightness, touch icon button  (for at least 2 seconds) .
 - Adjust brightness level by touching icon buttons  or  or scrolling the bargraph with your finger.
-  **NOTE:**
value setting range: 1 to 16.
- To confirm the selected brightness, simply quit this sub-menu by touching icon button  .

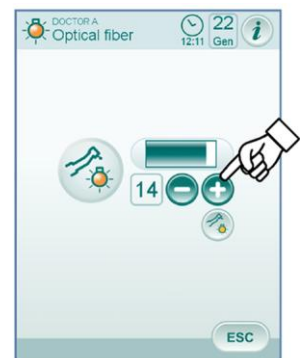

Colour profile adjustment.

- Touch icon button  to gradually shift from a "colder" colour profile to a "warmer" one.
- "AUTO" status activates the automatic white balance function, which can be used under particular conditions when the previous profiles are not satisfactory.



MIRROR function.

Touch icon button to shift from real to mirror image displaying mode. The icon corresponding to the active mode is shown on the TOUCH DISPLAY:

Real image.

Mirror image.

NOTE:
this function is available in LIVE mode, only.



FREEZE function.

This camera can freeze images on the monitor. This function can be enabled in 2 ways: by pressing touch key (**g**) on camera handpiece or by operating the foot control (see paragraph 5.2.). Each captured image is automatically stored inside console inner memory.

NOTE:
at the end of each treatment, we recommend transferring all the captured images inside a special folder associated to the patient.

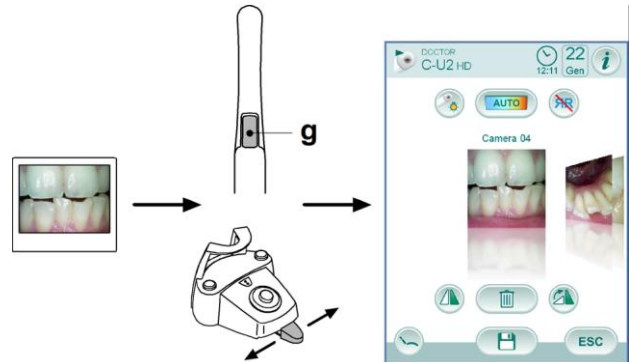

Captured image displaying.

To display a captured image in full-screen mode, proceed as follows:

- Scroll the saved images by touching the side thumbnails.
- Touch the central image to display it in full-screen mode.
- Now the following icon buttons are available on the TOUCH DISPLAY:

Image automatic improvement.

Increase image brightness.

Reduce image brightness.

Restore image original appearance.

Go back to "thumbnail" screen.

NOTE:
changes made to the image are automatically saved.

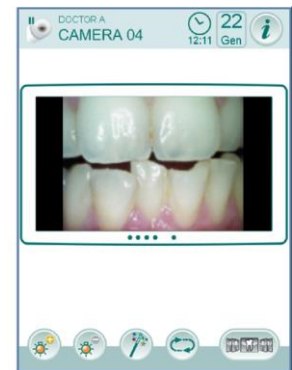

Moving the captured images to an internal memory or a USB key.

Each captured image is automatically stored inside console inner memory.

To transfer all captured images inside a specific working folder, proceed as follows:

- Put camera handpiece back in place.
- Touch icon button to access the navigation screen.
- Now the following icon buttons are available on the TOUCH DISPLAY:

Display other available options.

Go back to "thumbnail" screen.

Confirm image transfer to the selected folder.

Create a new folder.

- Touch the folder you want to select or create a new folder by touching icon button

Give a name to the new folder and confirm by touching icon button

- Now simply touch icon button to transfer all the images present inside console inner memory to the selected folder.

NOTE:
images are transferred all together, this is why we recommend carrying out this operation after seeing each patient.

The image folders saved on console internal memory can be copied at any time on a USB flash drive (see paragraph 5.1.1.2.16.).

NOTE:
console internal memory can store up to approx. 20,000 images taken by the camera. Once the available space is running out, a warning message will appear on the TOUCH DISPLAY.

Moving the captured images to iRYS.

To move all captured images to a specific iRYS patient folder, proceed as follows:

- Put camera handpiece back in place.
- Touch icon button to access the navigation screen.
- Select the desired patient folder by means of the various search functions (see paragraph 5.1.1.2.16.1.).
- Now simply touch icon button to move all the images present inside console internal memory to the selected folder.

NOTE:
images are transferred all together, this is why we recommend carrying out this operation after seeing each patient.

Moving the captured images to a PC with image management software.

- To move all captured images to a PC equipped with a generic image management software, proceed as follows:
- Put camera handpiece back in place.
- Touch icon button to move all the images present inside console internal memory to a pre-set PC folder.

NOTE:
the PC storage folder is set by means of the iCapture programme (see user's manual supplied with the programme).

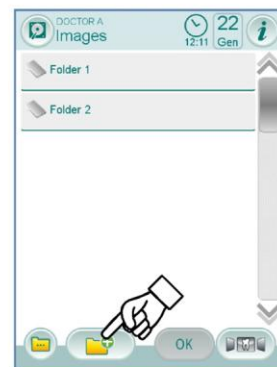
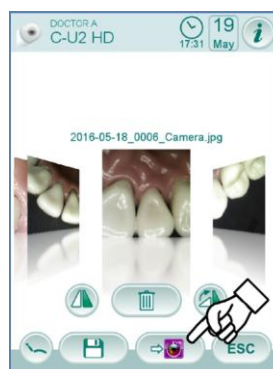
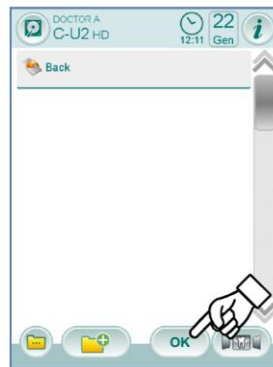
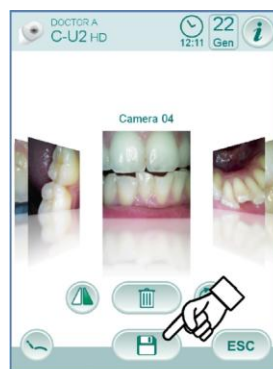

Handpiece status

An optical guide, illuminated by a multicolour LED indicator, found in the area near the control button (**g**), shows handpiece status as per the table given below:

Colour	Situation
Blue light flashes, very slowly	Handpiece in standby
Light blue steady light	Handpiece activated, live images displayed
Blue/ light blue flashing light	Handpiece in image freeze mode
Brief red flashes	Internal error: contact Technical Service

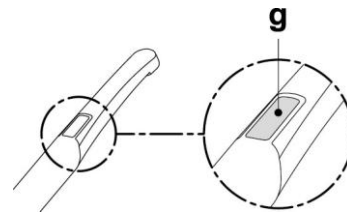

MyRay *iCapture*.

This programme allows the C-U2 camera to be set up when it is connected to a PC/WORKSTATION.

For a full description on how the MyRay *iCapture* programme works, refer to the instructions, in electronic format, supplied with the C-U2 handpiece.



Disposable infection control sheaths.

The camera can be a source of cross-contamination between patients. For this reason always use it with a disposable infection control sheath (code 97901590) and disinfect it on the outside after use everyday. The sheath (with white paper backing) is enclosed in two protective layers: a transparent one with blue tab at the front and a paper one at the back.

Follow the directions below to install a new infection control sheath:

- 1 Insert the camera handpiece tip between the layer with White tab and the rear paper backing. The lens, surrounded by the LEDS, must face down, towards the rear paper layer. Gently push the handpiece to the end of the sheath.
- 2 Pull the blue tab removing the protective films.
- 3 The camera is now protected and ready for use.

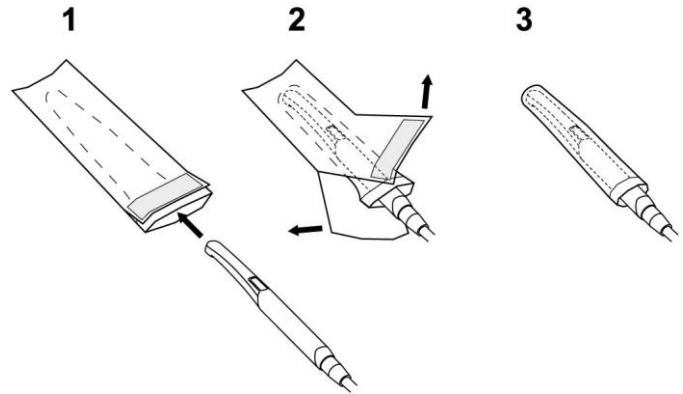

WARNING:

- Always make certain the handpiece is correctly inserted inside the infection control sheath.
- To ensure user and patient safety, always change the disposable infection control sheath before using the device on a new patient.
- Disposal: the disposable infection control sheaths are to be treated as special waste materials (like surgical gloves).

Cleaning and disinfection.

Clean the handpiece with a suitable product after each use: refer to paragraph 1.4.



WARNING:

- The dental camera is not designed for cold sterilization by being soaked, for example, in solutions such as glutaraldehyde or hydrogen peroxide.
- All products must be used as directed by the manufacturer.
- All materials used to clean and disinfect must be thrown away.

Maintenance and repairs.

The C-U2 dental camera does not require any particular maintenance. In the event of malfunctions, please send back the complete handpiece.



WARNING:

There are no parts that can be repaired on site. In the event of a malfunction, please contact an authorized dealer.

Returning parts.

- Please send back any defective devices in their original packaging. Do not reuse damaged boxes.
- The device must be disinfected before being shipped to prevent cross-contamination. Handpieces that have not been adequately cleaned and disinfected will not be accepted.



WARNING:

The sender shall be held responsible for any equipment damage occurred during shipment regardless of whether or not the devices are under warranty.

5.9. ZEN-Xi INTEGRATED SENSOR

The ZEN-Xi integrated sensor is a medical device used for the acquisition of intraoral X-rays in electronic format through the interface with the FULL TOUCH console or a Personal Computer.

WARNING:
Do not use the system for tasks other than the acquisition of intraoral X-rays, and do not use it if you are not an expert in dentistry and radiology.

Use

WARNING:
ZEN-Xi integrated sensor instructions for use are included with the equipment, please read carefully the warnings for use before turning sensor on.

Hereinafter is a list of the possible interactions with the FULL TOUCH console only:

- Turn ZEN-Xi sensor on (see instructions for use).
 If sensor is connected, after a few seconds the icon on the top left side of TOUCH DISPLAY will turn green and the ZEN-Xi sensor will be ready to receive an X-ray.
- Position the X-ray sensor inside patient oral cavity, then start the X-ray exposure (see instructions for use).

WARNING:
Before carrying out the X-ray exposure, make sure that the ZEN-Xi warning light is green.

After a few moments, the image will appear on the DISPLAY and on the screen of the connected monitor.

WARNING:
Do not take x-ray pictures on a patient when testing the system for the first time or verifying correct operation. Use phantoms to conduct tests.

- The main icon buttons available on the TOUCH DISPLAY are:

- Overturn the captured image.
- Turn captured image clockwise.
- Recall main controls of main screen.
- Delete captured image (a confirmation will be requested).
- Move the captured images to a folder of the internal memory or USB (with sensor off or in standby mode, only).
- Move the captured images to an iRYS folder (with sensor off or in standby mode, only).
- Move the captured images to the PC (with sensor off or in standby mode, only).
- Go back to the main screen without moving the captured images.

- After the first X-ray, other images can be acquired without having to carry out any other operation.
 Each X-ray is automatically saved inside console inner memory.

NOTE:
at the end of each treatment, we recommend transferring all X-ray images inside a special folder associated to the patient.

NOTE:
console internal memory can store up to approx. 1,000 X-ray images. Once the available space is running out, a warning message will appear on the TOUCH DISPLAY.

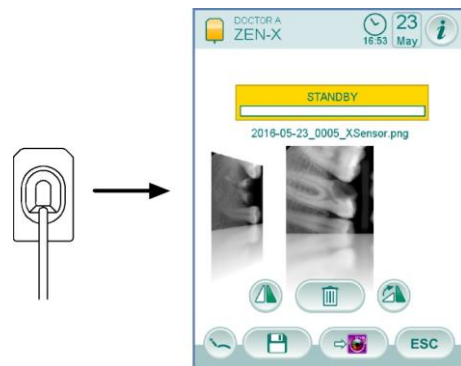
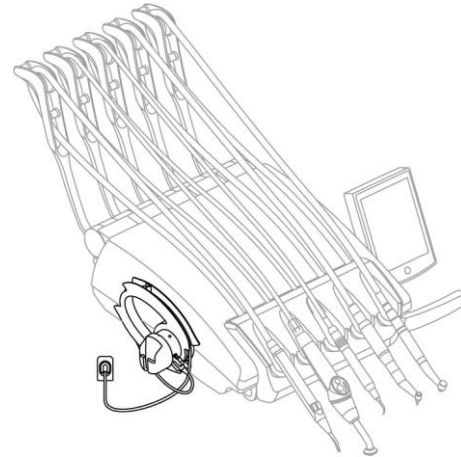

- When the ZEN-Xi sensor is turned off or set to standby mode, the screen with the X-ray images taken is still shown on the TOUCH DISPLAY, to go back to main screen, simply touch icon button .

X-ray image displaying.

The X-ray image displaying function is the same already described for the images taken by the C-U2 camera (see paragraph 5.8.).

X-ray image transfer.

The X-ray image transfer function is the same already described for the images taken by the C-U2 camera (see paragraph 5.8.).

5.10. PERISTALTIC PUMP

This device allows dispensing a saline solution through a disposable line without contact.

This device can be installed only if coupled with micromotor.



NOTE:

when used with micromotor, contra-angles with outer cooling or for hollow drills (type R20-L) must be used.

Description of the symbols present on the device.

- 1 Material in compliance with essential requirements of directive 93/42/EEC and subsequent changes.
- 2 WARNING: Pinching hazard.
Do not put your hands inside rotating parts.
- 3 Material sterilized by Ethylene Oxide.
- 4 Expiry date (yyyy-mm).
- 5 Disposable material.
- 6 Material identification code.

Commissioning.

- Aim and insert the IV pole (**a**) inside its seat and hang the bottle or container (**b**) of saline solution.
- Open the irrigation sterile line package (**c**) and take out the contents.



WARNING:

Wear disposable sterile gloves.

Make sure that package is whole and check irrigation line expiry date. Only CEFLA s.c. irrigation kits ensure a fail-safe operation. These are sterile and disposable lines, do not re-use them to prevent any microbiological contamination of the patient.

- Open peristaltic pump cover (**d**) by turning it up.
- Insert hose, making sure to position the larger diameter section inside the pump V-shaped seats. Pump rotates clockwise, so position hose so that the section coming from bag is inserted on pump left-hand side (see figure).
- Close cover (**d**). Should cover prove hard to be closed, open it again and check hose position.



WARNING:

Do not run pump with cover (d) open, finger pinching hazard.

- Pierce saline solution bottle cap (**b**) with the sharp end of irrigation line (**c**).

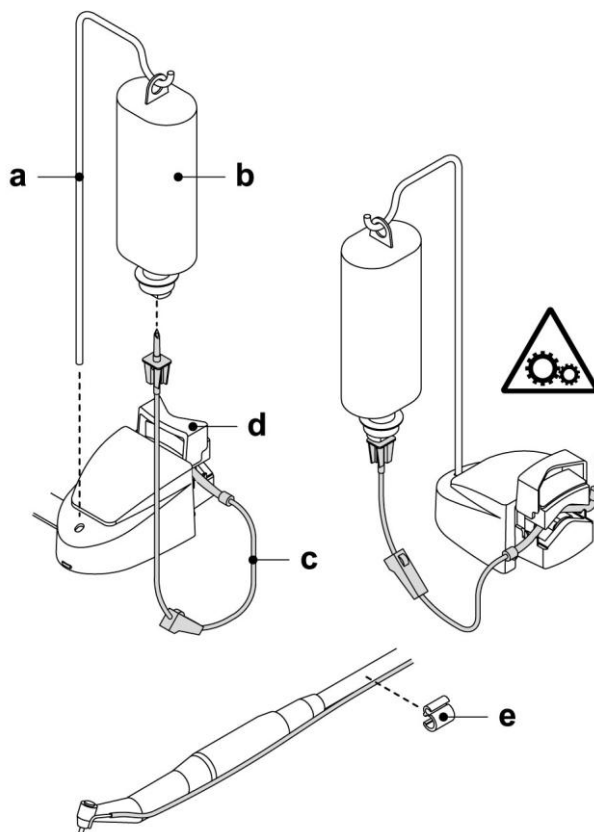
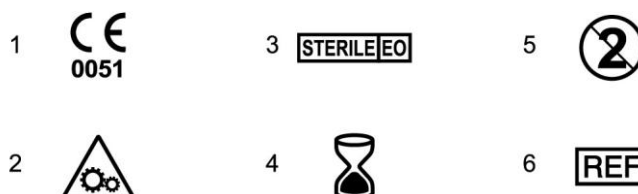
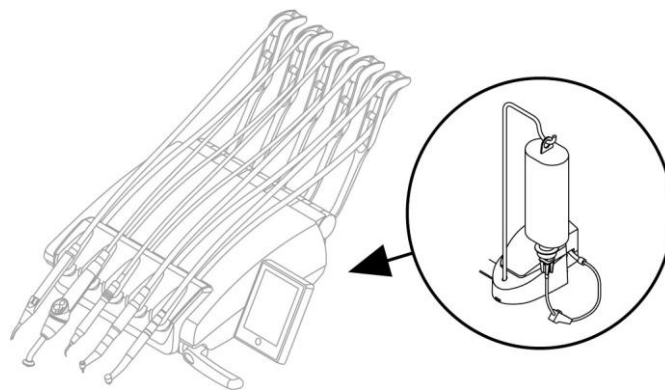

- Secure irrigation line hose on instrument cord with the special plastic

clips supplied with the sterile kit.



NOTE:

use type A for scaler cord, and type B for micromotor cord.

Operation.

To enable/disable peristaltic pump operation, extract micromotor and touch the relevant icon button:



Peristaltic pump not active.



Peristaltic pump active with quantity of delivered saline solution equal to 5.





NOTE:

pump activation is confirmed by an audible BEEP and by the appearance of the relevant box close to the value of delivered saline solution.



NOTE:

peristaltic pump activation is also signalled by a warning icon (see paragraph 5.1.) on the TOUCH DISPLAY showing also the value of delivered saline solution.

Should it be necessary, touch icon buttons  or  to change the quantity of saline solution delivered by the peristaltic pump.



NOTE:

value setting range: 1 to 5. The quantity of delivered solution associated to the settable values is:

- value 1: approx.35 cc/min,
- value 2: approx.50 cc/min,
- value 3: approx.70 cc/min,
- value 4: approx.90 cc/min,
- value 5: approx.100 cc/min.



NOTE:

the quantity of saline solution delivered by the peristaltic pump can also be edited when the instrument is active.



5.11. ELECTRONIC APEX LOCATOR

APEX LOCATOR, through the analysis of the variations of special electric signals, makes root apex location easier. If used together with a "file" (not supplied) for manual treatment, it proves useful also to measure canal length.

Besides using the apex locator in manual mode on this dental unit, this device can also be used with micromotor "ENDO" mode. The position of the instruments used on handpieces can be monitored since, through instrument hoses, APEX LOCATOR signals are directly transferred to the files, thus allowing to monitor canal position during treatments.

Component description.

- 1 APEX LOCATOR external wiring.
- 1.1 APEX LOCATOR external wiring - neutral pole.
- 1.2 APEX LOCATOR external wiring - active pole.
- 2 Hook-type electrode.
- 3 Probe.
- 4 APEX LOCATOR clip connecting tweezers.
- 5 APEX LOCATOR external wiring port.

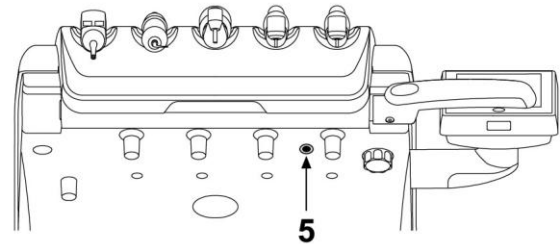
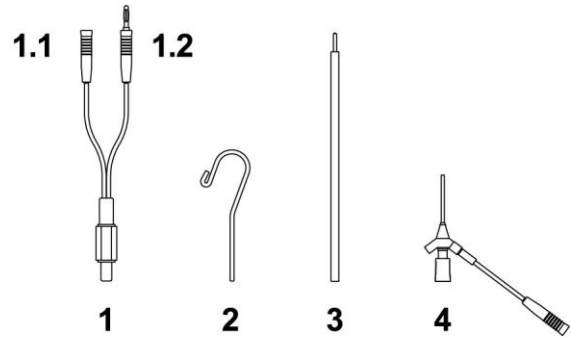

Operation.

- On this dental unit, APEX LOCATOR is automatically activated upon external wiring (1) insertion inside the special socket (5) positioned under dentist's board.
- Once enabled, the menu for alarm threshold setting appears on the display (see paragraph 5.1.1.2.17.).
- Electrode application:
 - Connect hook-type electrode (2) to neutral pole (1.1) and position it on patient's lip.
 - Connect active pole (1.2) to file (not supplied) inserted inside the root canal; connection to the file can be carried out through probe (3) or through the special tweezers (4) or through the special pre-settings made for handpieces.



WARNING:
Electrodes are not supplied sterile.

Indications on the display.

- The bargraph on display left-hand side indicates file position compared to apex. The numerical indications "1 2 3" refer to the relative distance between instrument and apex.
- The APEX icon displays the distance from instrument to apex.



NOTE:
the indication "> 4" signals that the file is too far from apex to be measured.

- The ALARM icon displays the set alarm threshold.
The alarm threshold refers to the distance between instrument and apex above which an audible signal - progressively increasing as instrument gets closer to apex - is generated.
To set the alarm threshold, see paragraph 5.1.1.2.17.

Both graphic and numerical indications are constantly updated while file is inserted inside canal.

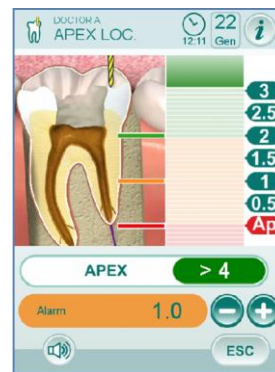

APEX LOCATOR combined with electric micromotor.

The APEX LOCATOR can also be used in combination with the electric micromotor when set to ENDO mode or to RECIPROCATING mode.

When the APEX LOCATOR is enabled, if electric micromotor is extracted in ENDO mode both the information relating to the micromotor and those relating to APEX LOCATOR (bargraph and APEX values) are shown at the same time on the display.

During electric micromotor operation, the keys are associated to instrument functions, and APEX LOCATOR alarm threshold cannot be edited but by putting instrument back in place.

With the Goldspeed EVO E4® and Sirona Endo 6:1 contra angles it is also possible to enable the APEX STOP function, which automatically stops the micromotor once the alarm threshold is reached.



APEX STOP disabled

APEX STOP enabled

Root canal length detection.

- The use of the manual file is of the utmost importance for canal detection. The correct procedure entails file insertion inside canal until reaching indication 0.5.
- Continue inserting the file with a slow clockwise rotation until the APEX indication appears on the instrument.
- Once APEX indication appears, move the file backward by turning it counter clockwise until reaching again the value of 0.5. Position a rubber stopper close to the occlusal surface as a reference point to define the work length inside root canal.
- Make an X-ray to check file correct positioning.
- Remove file from canal and measure the work length with a ruler. Deduct a safety value of 0.5-1 mm from the reading.



WARNING:

Use APEX LOCATOR always in combination with X-ray test to accurately define apex position. Different, and not always predictable, morphological conditions could lead to inaccurate readings.

For example:

- excessively wide root canal;
- re-treatments;
- broken roots;
- presence of metal crowns.

6. ASSISTANT'S BOARD OPERATION

Main features.

- Two articulated arms secure board (a) to water unit (b) allowing it to be placed in the most convenient work position.
Fixed arm (c) can turn by 120°.
- The pantograph arm (e) allows a vertical stroke of the assistant's board of 335 mm, in 6 working positions.



NOTE:

to move assistant's board to bottom position, simply lift it to the top position, then lower it.

- The assistant's board (a) comes with a control console (d) with buttons used to operate the dental chair and water unit.
- The assistant's board can hold 2 suction tubes and 3 instruments.
- The assistant's board comes with sliding rollers (f) that guide and hold up the suction tubes.

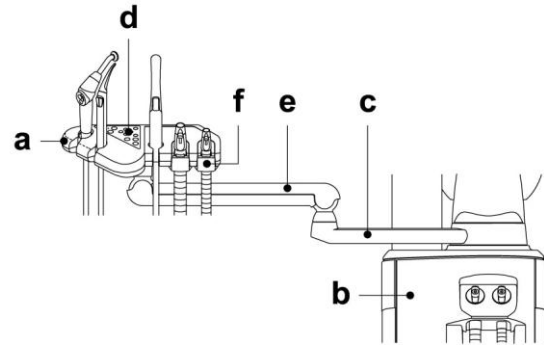

Cleaning the sliding rollers.

Push down and take off the sliding rollers (f).

Clean the sliding rollers with a suitable product: refer to paragraph 1.4.

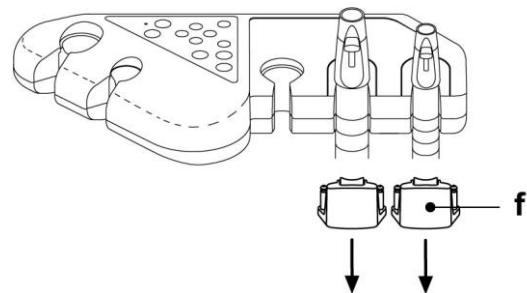

6.1. ASSISTANT'S BOARD CONSOLE

Description of the buttons:

- Operating light on/off button.
- Water-to-cup button.
- Water-to-bowl button.
- Reset position recall button.
- Rinsing position recall button.
- Seat up and programmed position A recall button.
- Backrest up and programmed position B recall button.
- Seat down and programmed position C recall button.
- Backrest down and emergency position D recall button.
- BIOSTER cycle quick activation button (with relevant warning LED).
- S.H.S. system enabling/disabling button (with relevant warning LED).



NOTE:

operation of dental chair buttons:

- Button pressed shortly: automatic recall of set position.
- Button held pressed: manual positioning.

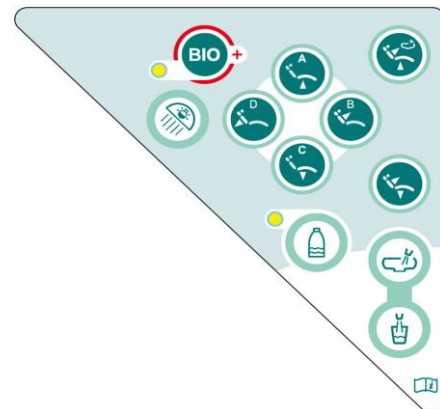

6.2. SYRINGE

For detailed information regarding operation of this instrument, see paragraph 5.3.

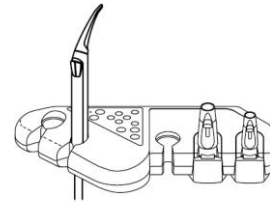

6.3. T LED CURING LIGHT

For detailed information regarding operation of this instrument, see paragraph 5.7.

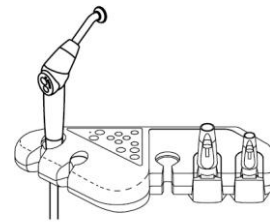

6.4. C-U2 DENTAL CAMERA

For detailed information regarding operation of this instrument, see paragraph 5.8.

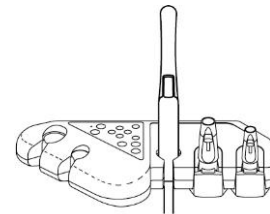

6.5. SUCTION TUBES

Suction starts by taking the tube off the board.

To adjust suction power, use the slider (**a**) located on the suction tube holder grip.

NOTE:
suction tube suction control can be started/stopped by pressing the pedal (**o**) on water unit base.

NOTE:
when the tube is put back in place, suction stops approximately 2 seconds later. This is done to dry the suction tubes.

Removing the suction tubes.

WARNING:
Always wear goggles and gloves to prevent contact with infected material when removing the suction tubes.

Remove the suction tubes from the conveyor fittings by turning and pulling the tube fitting.

Detach the suction tubes from the holders by turning and pulling the tube fitting.

WARNING:
Never directly grasp the suction tube.

Cleaning the suction tubes.

As the dental units may be equipped with different suction systems (liquid or wet ring, air) carefully follow the instructions provided by the suction system manufacturer when disinfecting the system regarding the product to be used, times and directions for use.

WARNING:
For cleaning of the suction system, it is recommended to use STER 3 PLUS (CEFLA s.c.) diluted in a 6% solution (equivalent to 60 ml of product in 1 litre of water).

Sterilization.

- Suction tube holder terminals: steam autoclave up to 135° C following the instructions for the use of the device.
- Suction tubes: soak to cold-sterilise.

WARNING:
With the tubes, never use procedures where temperature exceeds 55° C.

Maintenance.

Periodically lubricate the O-rings of the suction tube holder terminals (see Paragraph 9.4.) using **S1-Protective Lubricant for O-Rings** (CEFLA s.c.).

Note about biocompatibility.

Only use suction tubes supplied with the dental unit and original spare tubes.

The suction tubes must comply with Biocompatibility Standard ISO 10993.

ISOLITE suction tube.

For ISOLITE suction tube operation, please refer to the specific use instructions given by the manufacturer.

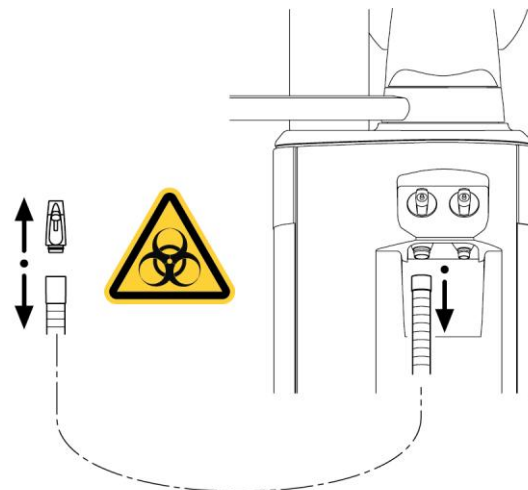
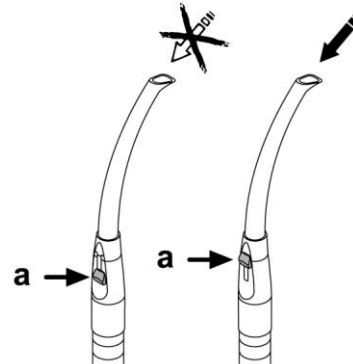
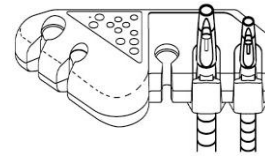

6.6. TRAY HOLDER

The tray holder module (**a**) is made of stainless steel and can easily be removed from its support.

Tray holder support can rotate both clockwise and counter clockwise, so as to be positioned in the most convenient position for the operator.

To lock/unlock the tray holder support, simply turn the clutch knob (**b**).



WARNING:

Maximum permitted load on the tray holder: 1 kg distributed.

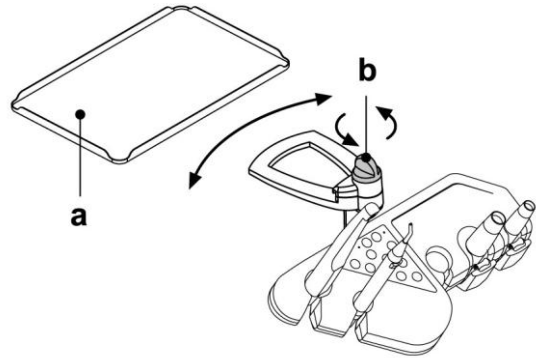

7. WATER UNIT OPERATION

7.1. FILL CUP AND BOWL

The bowl can be turned by 215° on the water unit by hand or using a motor drive (optional).

The bowl and the water-to-cup spout can be removed to make cleaning operations easier.

Control icon buttons.



Water-to-cup delivery control icon button.



Water-to-bowl delivery control icon button.

Cup sensor

An optical sensor detecting cup presence and automatically enabling cup filling is installed under cup spout.

Sensor operates as follows:

- once cup has been positioned under spout, water starts being delivered after 2 seconds and for 2 seconds (this time cannot be edited),
- after cup is removed, the filling cycle can be repeated after 3 seconds,
- during the filling cycle, by removing cup and/or pressing the "WATER-TO-CUP" button, water delivery is immediately interrupted.



NOTE:

to disable cup sensor, see paragraph 5.1.1.2.5.

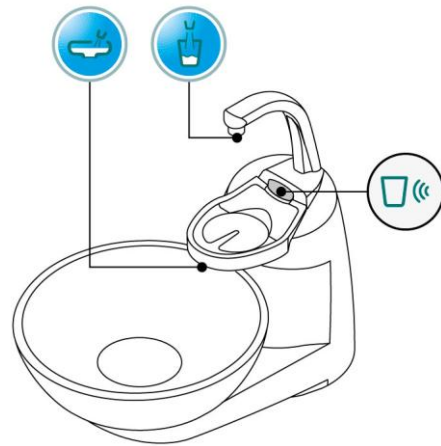

Water-to-cup level adjustment.

See paragraph 5.1.1.2.5.

Water-to-cup temperature adjustment.

See paragraph 5.1.1.2.5.

Bowl flushing setting.

Water-to-bowl delivery can take place in a timed or manual manner (ON/OFF by shortly pressing the relevant control button).

To set the desired operating mode and water delivery time. See paragraph 5.1.1.2.4.

Bowl flushing automatic operation setting.

Bowl flushing automatically starts in the following cases:

- by pressing the "Water-to-cup" button,
- by pressing the "Dental chair reset position" button,
- by pressing the "Dental chair rinse position" button.

To edit this operating mode, see paragraph 5.1.1.2.2.1.

Bowl movement.

 Bowl counter-clockwise movement control icon button (active only with motor-driven bowl).

 Bowl clockwise movement control icon button (active only with motor-driven bowl).

 **NOTE:**
bowl can also be manually moved by turning it with your hands.

Bowl automatic movements (with motor-driven bowl, only).

Bowl automatically moves:

- by pressing "Dental chair rinsing position" button,

 **NOTE:**
in this case, bowl position can also be set (see paragraph 5.1.2).

- by pressing the "Dental chair reset position" button,
- by pressing the button to recall 1 of the 4 available programmes.

To change this operating mode, see paragraph 5.1.1.2.6.

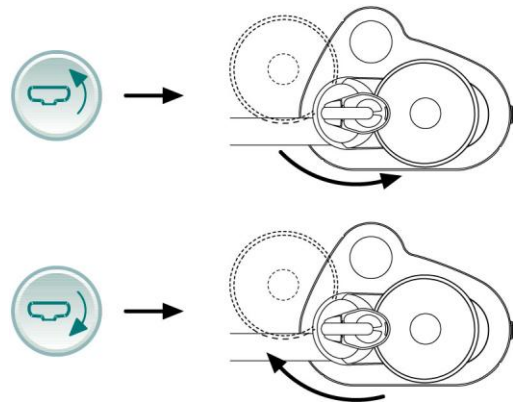

Spout, bowl and bowl filter removal.

- Pull up the spout (I) and take it off.
- Pull up the filter (q) and its cover (p) from the bowl to remove them.
- Release bowl (m) by turning it counter clockwise, then pull it up to remove it.

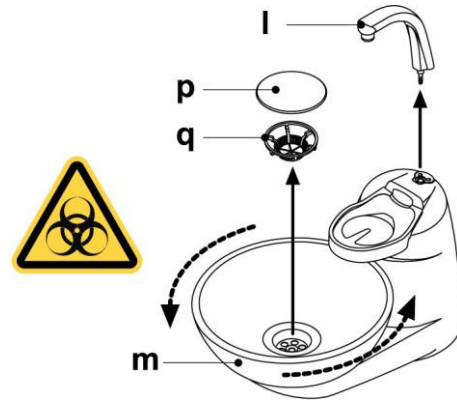

Disinfecting and cleaning.

 **WARNING:**
Always wear gloves to prevent contact with infected material when cleaning the bowl and bowl filter.

The parts are to be cleaned daily at the end of each working day.

- Spouts and bowl: thoroughly wash with a specially formulated scale-remover (such as MD 550 Orotol DÜRR).
- Bowl filter: clean with running water and commercially-available cleaning products.

 **WARNING:**
Do not use acid or harsh products.

7.2. S.H.S. SYSTEM



Description of the system.

S.H.S. system features a tank (a) for distilled water.

The tank has a total capacity of 1.8 litres.

Distilled water supplies:

- the sprays of all the instruments present on dentist's and assistant's boards,
- the syringe present on the assistant's board,
- the cup filling system,
- water quick coupling (if available).

The icon button  on the TOUCH DISPLAY (see paragraph 5.1.1.2.12.) or button  on assistant's board control panel allow enabling/disabling distilled water supply.

 **NOTE:**
distilled water supply status is highlighted by icon (A) appearing on the console display.

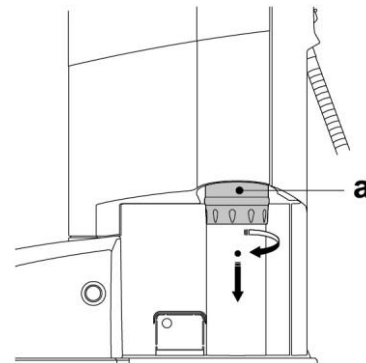

Tank reserve warning.

When the fluid inside the tank drops below the reserve level, a special warning icon (B) appears on dentist's board console.

Tank filling.

Once tank min.level is reached (approx. 500 cc), fill it as follows:

- Disable the S.H.S. system by touching the  icon or pressing the button on the assistant's board control panel. Check that icon (B) disappears from the console display



NOTE:

during this operation the pressurised air present inside tank will be automatically bled to the outside.

- Remove tank (a) by turning it clockwise.
- Pour distilled water inside tank until reaching the max. level.



WARNING:



Use distilled water only. For enhanced hygiene, it can be added with 600 parts per million (ppm) of hydrogen peroxide using 20 ml of Peroxy Ag+ per litre of distilled water, or oxygenated water (20 ml of 3% oxygenated water per litre of distilled water).

- Fit tank back in place by turning it counter-clockwise.



WARNING:

Make sure that tank is duly fastened.

- Touch icon button  or press button  to enable the S.H.S. system again and confirm the filling procedure has been completed successfully.

Check that icon (A) appears on console display



WARNING:

If you are going to be absent from the surgery for long periods of time (holidays), completely empty the tank (a) before leaving.

Tank cleaning.

We recommend cold sterilising tank only at regular intervals (at least once a month) using a peracetic acid based product and proceeding as follows:

- remove tank from dental unit and drain it completely,
- prepare the solution of the peracetic acid based product by following the instructions given by the manufacturer,
- fill tank to the brim with the peracetic acid solution,
- leave the peracetic acid solution inside tank for the time recommended by the manufacturer,
- drain all peracetic acid solution from tank,
- rinse tank with distilled water,
- fill tank with distilled water, if necessary after adding the above-indicated substances,
- fit tank back in place inside dental unit.

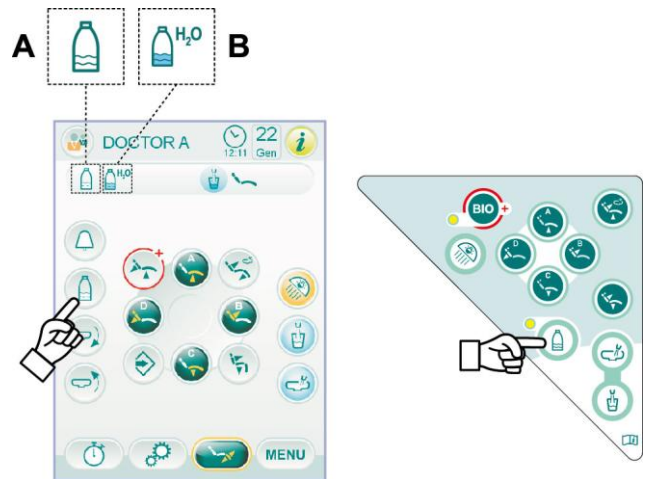

7.3. W.H.E. SYSTEM (WATER HYGIENIZATION EQUIPMENT)

The W.H.E. system ensures a safe, physical, separation of the dental unit water system from the water mains thanks to a water free fall section (in compliance with EN 1717).

In addition, system continuously delivers hydrogen peroxide inside water circuit with a final concentration inside ducts of 0.06% (600 ppm), which is suitable to carry out bacteriostasis.

To this end, the use of **PEROXY Ag+** (CEFLA s.c.) is recommended; nevertheless, also 3% oxygenated water can be used.

Description of the system.

The W.H.E. system is positioned inside the connection box and is always active.

In addition, system features a tank (a) positioned inside the water unit and suitable to contain approx. 500 cc. of oxygenated water.

A special icon (G) appearing on the TOUCH DISPLAY indicates that the WHE system is active.

NOTE:
the W.H.E. system is automatically disabled when the S.H.S. system is enabled (if installed).

Disinfectant fluid running out warning.

When the disinfectant fluid present inside tank (a) is running out, a special warning icon (H) appears on the TOUCH DISPLAY, an error message appears on the display and 3 warning BEEPS are emitted and repeated whenever dental unit is turned on.

WARNING:
If disinfectant fluid has run out, the operating unit will nevertheless continue working, but it will use UNTREATED mains water.
We recommend topping up disinfectant fluid as soon as possible.

Disinfectant fluid tank filling.

When there is no more disinfectant fluid inside tank, proceed as follows:

- Open tank flap.
- Remove plug (k) and pour disinfectant fluid inside tank until it is full.

NOTE:
plug shape allows it to be used as a funnel to make filling easier.

WARNING:
When filling tank, do not use too much disinfectant to avoid any excess to spill out on the floor.
We recommend using 500 cc max. after reserve warning or 700 cc max. with completely empty tank.

- Refit plug and close tank flap.

WARNING:
To fill up, use pure **PEROXY Ag+** or 3% oxygenated water (10 volumes) only, without diluting them.

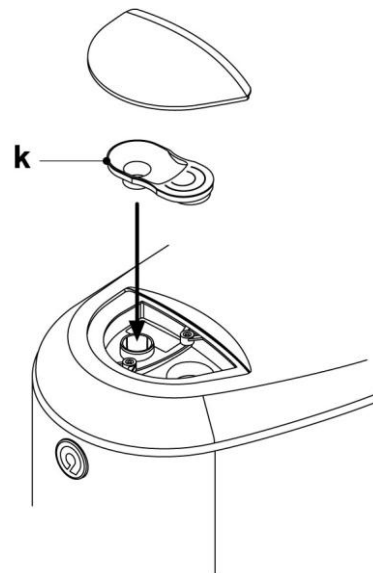
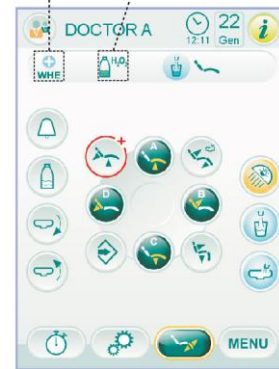
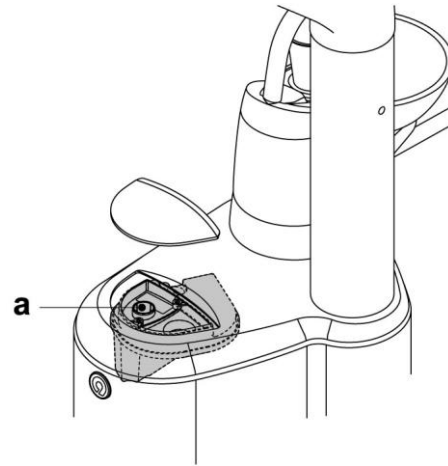

Emptying the W.H.E. system water circuit.

This function allows emptying the W.H.E. system water circuit in case the dental unit must stay off for several days.

For emptying procedure, see paragraph 5.1.1.2.3.

Error messages on console display.

If system detects a malfunction, an error message will be displayed (see paragraph 10).

If the detected error is negligible, the dental unit continues working, while in case of severe errors, the dental unit will be blocked and Technical Service is required.

PEROXY Ag+ storage.

For proper PEROXY Ag+ storage, follow the manufacturer's instructions given on the package.

It is important to keep the package tightly closed and stored in a cool place at a temperature not exceeding 25°C.

**WARNING:**

Never leave PEROXY Ag+ or oxygenated water in the tank (a) for more than one month.

If you are going to be absent from the surgery for long periods of time (holidays), completely empty the tank (a) before leaving.

**NOTE:**

to empty tank, use a suction tube.

7.4. BIOSTER DISINFECTION AUTOMATIC SYSTEM

Description of the system.

This system allows carrying out an automatic disinfection cycle of the water circuits of the following instruments:

- all instruments present on dentist's board,
- the syringe present on the assistant's board,
- suction tubes (if the suction tube flushing system is installed),
- the water-to-cup ducts.

In addition, system features a tank (a) positioned inside the water unit and suitable to contain approx. 590 cc. of oxygenated water.

The disinfection cycle can be set and features a safety electronic system in compliance with the Medical Device Directive EEC 93/42 as subsequently amended.

 **WARNING:**
Carry out a disinfection cycle at the end of every work day.

Disinfectant fluid running out warning.

When the disinfectant fluid present inside tank (a) is running out, a special warning icon (H) appears on the TOUCH DISPLAY, an error message appears on the display and 3 warning BEEPS are emitted and repeated whenever dental unit is turned on.

Disinfectant fluid tank filling.

When there is no more disinfectant fluid inside tank, proceed as already specified in paragraph 7.3.

 **WARNING:**
To fill up, use pure PEROXY Ag+ or 3% oxygenated water (10 volumes) only, without diluting them.

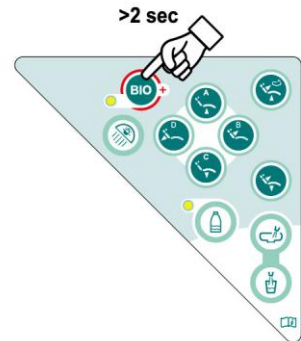
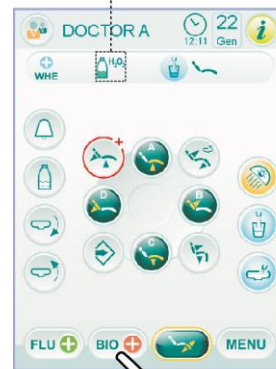
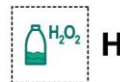
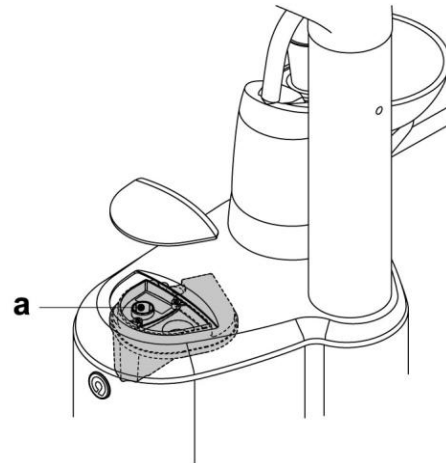

Setting the disinfection cycle.

- Check disinfectant fluid level inside tank and, if necessary, top up.

 **NOTE:**
disinfectant cycle will not be activated if the fluid level inside tank is below reserve level.

- Use the TOUCH DISPLAY or keep the BIO button on assistant's board pressed (for at least 2 seconds) to access the "BIOSTER disinfection cycle setting" menu and set the residence time of the disinfectant fluid inside instrument water ducts (see paragraph 5.1.1.2.1.).
- Position the special container (d) for the instruments to be disinfected on the bowl.
- Insert the cords of the instruments to be disinfected in the container.

 **WARNING:**
For the syringe instrument you need to use the special adapter (f) and the heating system must be off.
The micromotor cord must be fully inserted inside motor body.
Turbine and scaler cords must be inserted without the handpiece.

- Should you wish to disinfect suction tubes, insert tube terminals inside the special couplings under manifold (see paragraph 7.5.).

 **NOTE:**
make sure that tube terminals are open.

- If water-to-cup duct disinfection is selected, place the special supplied container (e) under cup spout.
- Make sure that spray cocks (g), positioned on board lower side, are open.

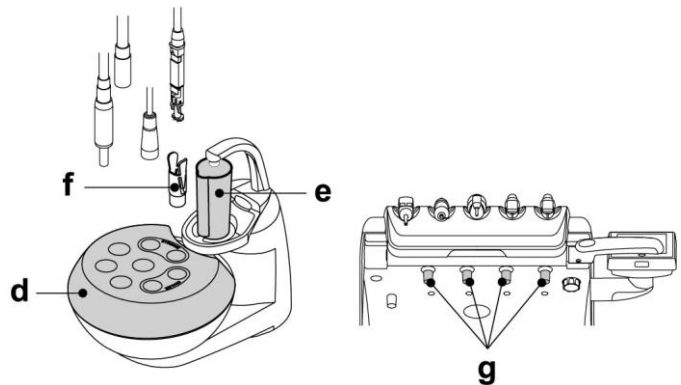

Performing the disinfection cycle.

- Start the automatic disinfection cycle by touching icon button **PLAY** (see paragraph 5.1.1.2.1.) on the TOUCH DISPLAY or by pressing the BIO button on the assistant's board.
- Now the system automatically performs the following operations:
 - emptying water ducts of instruments with air,
 - introduction of disinfectant fluid and starting of the counting of the previously-set residence time,
 - once time has elapsed, start of a new duct emptying phase with air,
 - ducts flushing with mains water or with distilled water (only if distilled water supply system is installed and active).
- At the end of the disinfection cycle ("Cycle end: put instruments back in place" will appear on the TOUCH DISPLAY), simply put extracted instruments back in place to go back to standard working conditions.

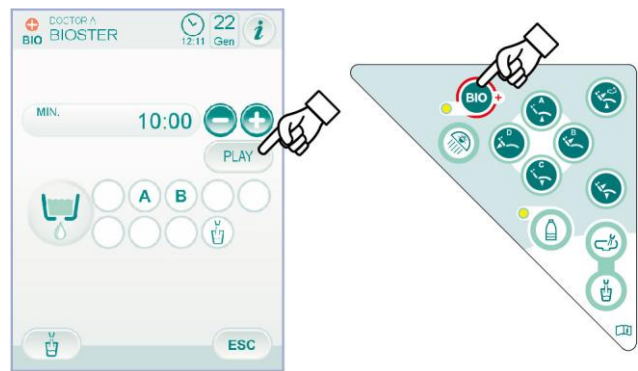

Disinfection cycle interruption.

- Touch icon button **STOP** to interrupt the disinfection cycle at any time.
- A confirmation message will appear on the console display:
 - touch icon button **NO** if you do not want to stop disinfection and cycle menu will appear back on the display.
 - touch icon button **YES** to interrupt the disinfection cycle; an intermediate menu showing set time and extracted instruments will appear on the display.



NOTE:

now the dental unit is in lockout mode.

- Now the following options are available:
 - touch icon button **ESC** to go back to time setting starting menu where you can restart the disinfection cycle from the beginning by editing, if necessary, the disinfectant residence time and/or adding other instruments to be disinfected,
 - touch icon button **↺** to access the "Instrument flushing" menu to flush the ducts of the extracted instruments,
 - touch icon button **PLAY** to resume disinfection cycle from where it was interrupted.
- From "Instrument flushing" menu:
 - touch icon button **ESC** to go back to time setting starting menu where you can restart the disinfection cycle from the beginning by editing, if necessary, the disinfectant residence time and/or adding other instruments to be disinfected,
 - touch icon button **PLAY** to enable the emptying and flushing cycle of extracted instrument ducts with mains water or distilled water (if the S.H.S. system is installed),
 - touch icon button **↺** to go back to the previous menu.



NOTE:

at the end of the flushing cycle, "Cycle end: put instruments back in place" will appear on the display; simply put extracted instruments back in place to go back to standard working conditions.



PEROXY Ag+ storage.

For proper PEROXY Ag+ storage, follow the manufacturer's instructions given on the package.

It is important to keep the package tightly closed and stored in a cool place at a temperature not exceeding 25°C.



WARNING:

Never leave PEROXY Ag+ or oxygenated water in the tank (a) for more than one month.
If you are going to be absent from the surgery for long periods of time (holidays), completely empty the tank (a) before leaving.



NOTE:

to empty tank, use a suction tube.

Error messages on console display.

If system detects a malfunction, an error message will be displayed (see paragraph 10).

WARNING:
In case of irregular interruption of the disinfection cycle, the equipment will stay in lockout condition until the disinfection cycle is run again or a flushing cycle is carried out.

7.5. AUTOMATIC INSTRUMENT FLUSHING CYCLE

Description of the system.

The automatic FLUSHING cycle allows to carry out an automatic flushing cycle to renew water present in the water ducts of the instruments on the dentist's and the assistant's boards and the water-to-cup duct.

Flushing can be carried out with mains water, with treated water (if W.H.E. system is installed) or with distilled water (if the S.H.S. system is installed)

The cycle duration time can be set from 1 to 5 minutes.

WARNING:
It is advisable to carry out a FLUSHING cycle at the beginning of each work day and between two patients.

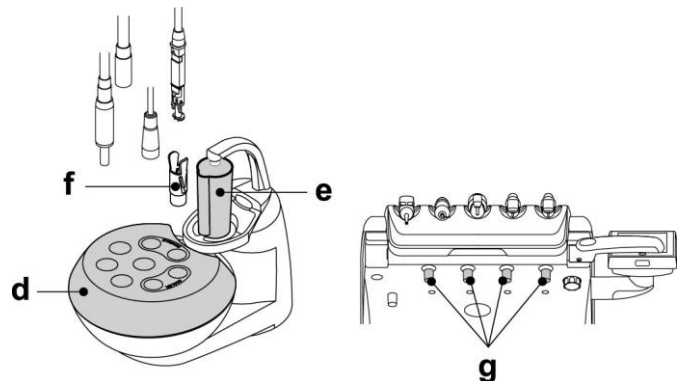

Setting the FLUSHING cycle.

- If the S.H.S. system is installed and you wish to carry out the flushing cycle with distilled water, make sure that the relevant icon (A) is displayed (see paragraph 7.2.).

NOTE:
it is advisable to execute the flushing cycle with distilled water tank completely full.

- Use the TOUCH DISPLAY to access the "FLUSHING cycle setting" menu, and set cycle time (see paragraph 5.1.1.2.3.).
- Position the special container (d) for the instruments to be disinfected on the bowl.
- Insert the cords of the instruments to be disinfected in the container.

WARNING:
For the syringe instrument you need to use the special adapter (f) and the heating system must be off.
The micromotor cord must be fully inserted inside motor body.
Turbine and scaler cords must be inserted without the handpiece.

- Insert the special supplied container (e) under the cup spout.
- Make sure that spray cocks (g), positioned on board lower side, are open.

Performing the FLUSHING cycle.

- Touch icon button **PLAY** on the TOUCH DISPLAY to start the flushing cycle (see paragraph 5.1.1.2.2.).
- At the end of the flushing cycle ("Cycle end: put instruments back in place" will appear on the display), simply put extracted instruments back in place to go back to standard working conditions.

Stopping the FLUSHING cycle.

Touch icon button **STOP** at any time to interrupt the flushing cycle and go back to cycle setting starting menu.

Error messages on console display.

If system detects a malfunction, an error message will be displayed (see paragraph 10).

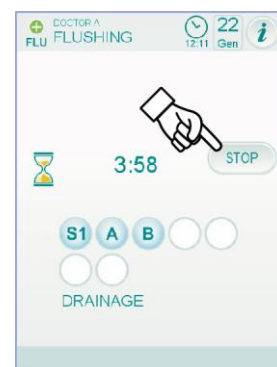
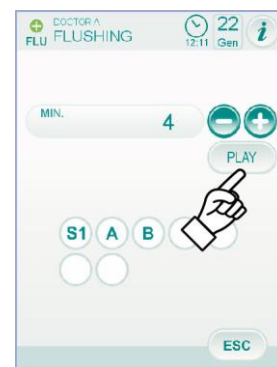

7.6. A.C.V.S. SYSTEM (AUTOMATIC CLEANING VACUUM SYSTEM)

Description of the system.

This system allows cleaning the surgical suction system. System features a tank (c) with detergent fluid and two couplings (d) used for suction tube flushing.

Detergent fluid tank has a total capacity of 500 cc.

The flushing cycle is automatic and should usually be carried out at the end of each surgery so as to complete the operating unit cleaning and disinfection procedure.



WARNING:

It is recommended to use STER 3 PLUS (CEFLA s.c.) diluted as follows: 1 measuring cap (in case of commercial package) or 2 measuring caps (in case of complimentary package) in one litre of water (6% solution).

How to start the flushing cycle.

To start the flushing cycle, proceed as specified below:

- Make sure that tank (c) contains enough detergent fluid (at least half tank must be full).
- Remove suction tube terminals from assistant's board supports, making sure that suction motor starts.
- Open suction tube terminal mechanical locks.
- Insert suction tube terminals inside the relevant couplings (d) located under manifold.

The vacuum created inside the Venturi tubes starts the flushing cycle.

- Flushing cycle operating steps:
 - mains water supply for 50 sec. with intermittent operation (2 sec. ON - 1 sec. OFF),
 - stop of water flow and supply of 10cc. of disinfectant fluid,
 - stop of disinfection fluid supply and suction continuation for 10 sec.
- The interruption of the suction flow, with consequent motor stop, determines flushing cycle end. The message "Put suction tubes back in place" will appear on the display.
- Now simply put suction tube terminals back into their supports on assistant's board to go back to working condition.

Tank filling.

When detergent fluid inside red tank (c) drops below the min. level, proceed as follows:

- Open the water unit side cover (see paragraph 7.7.).
- Remove red tank (c), taking care not to lift it up.
- Remove plug (e) and pour disinfectant fluid inside tank until it is full.



WARNING:

When filling tank, do not use too much disinfectant fluid to prevent any excess from spilling out on the floor.

We recommend using 450 cc max. after min. level warning or 550 cc max. with completely empty tank.

- Refit plug and tank.
- Lastly, close the water unit side cover.

Stopping the flushing cycle.

If system detects a malfunction, an error message will be displayed (see paragraph 10).



NOTE:

once stop causes are removed, the flushing cycle will restart automatically.

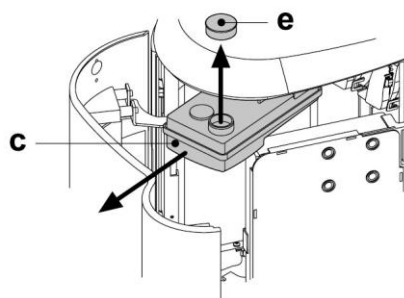
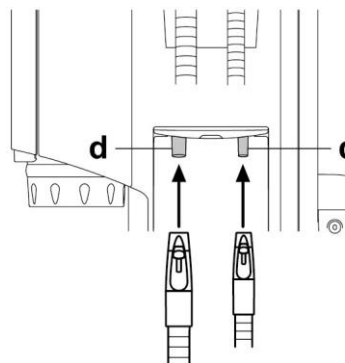
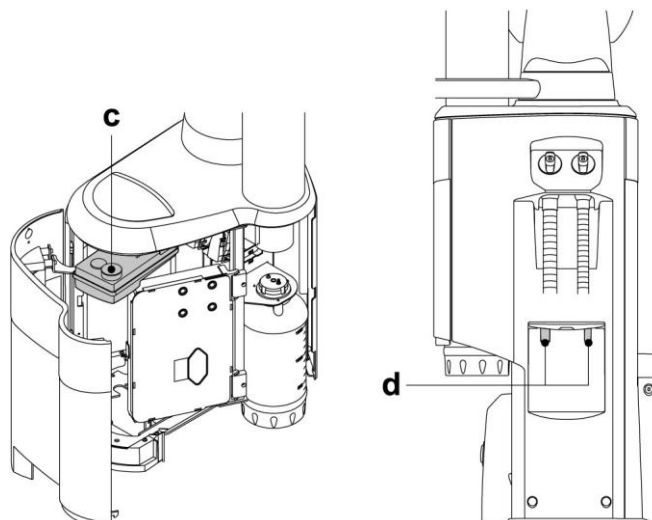

7.7. OPENING/CLOSING THE WATER UNIT SIDE COVER

Opening the cover.

- turn water unit side cover (**a**) after having released the special locking handle (**h**).

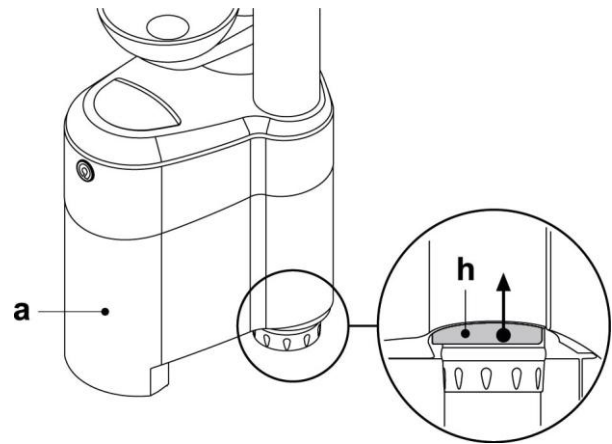

Closing the cover.

- close water unit side cover, making sure it locks with handle (**h**).

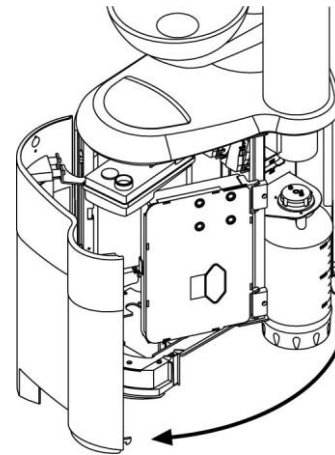

8. ACCESSORIES

8.1. OPERATING LAMP

The operating light comes in 2 models:

- (1) Light with halogen light source, VENUS model.
- (2) Lamp with LED light source, VENUS PLUS-L model.

The instructions for use and maintenance of the lamps are available in PDF format and can be downloaded from the download area of the website www.anthos.com.

 **NOTE:**
during the automatic movements of the dental chair, the light automatically turns off to prevent blinding the patient.

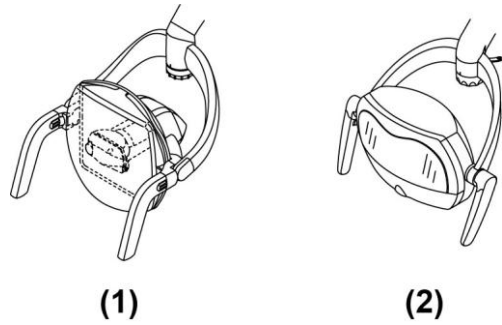

8.2. MONITOR ON LAMP POLE

The instructions for use and maintenance of the monitor are provided with the device.

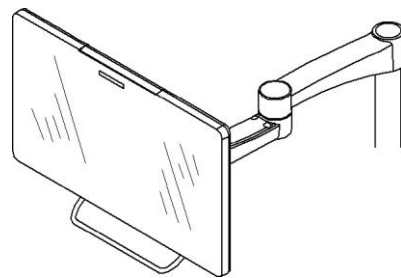



8.3. NEGATOSCOPE FOR PANORAMIC X-RAYS

An x-ray film viewer for panoramic x-rays can be mounted on all SIDE DELIVERY version dentist's boards.

The screen dimensions are as follows: H=210mm, L=300mm.

Turn on negatoscope, simply turn special switch (a):

-  Negatoscope on.
-  Negatoscope off.

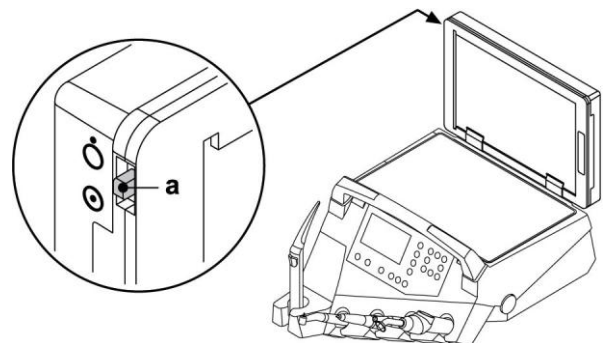

8.4. AIR/WATER/230V QUICK-COUPLINGS

The 230V/air/water quick-couplings are located on the side of the utility service centre connection box.



WARNING:

Switch off the equipment before attempting to connect or disconnect the air/water outlets.

Technical specifications.

- Power outlet: 230Vac 2A in accordance with IEC/EN 60320-2-2/F (only on dental units with 230Vac power supply).
- Air quick-coupling pressure: 6 Bar.
- Water quick-coupling pressure:
 - mains water, 2.5 Bar
 - with S.H.S. system, 1.8 Bar
 - with W.H.E. system, 3 Bar
- Water quick-coupling flow rate:
 - mains water, 1800 ml/min
 - with S.H.S. system, 950 ml/min
 - with W.H.E. system, 400 ml/min



NOTE:

with the S.H.S. system, in order to use the quick-coupling with mains water, the distilled water tank needs to be disabled (see paragraph 7.2.).

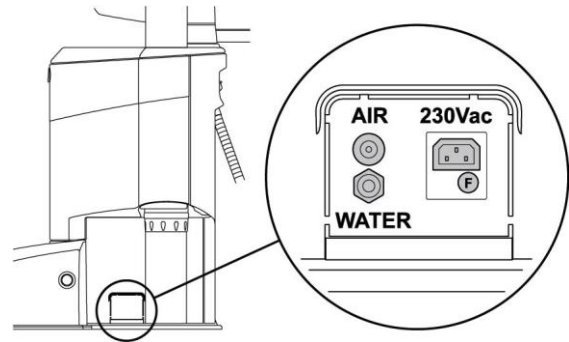

8.5. AUXILIARY TRAY HOLDER

Applied only on models L9 SIDE DELIVERY.

Tray holder can contain two standard size trays.

Turn knob (**b**) to adjust vertical movement based on load:

- turn clockwise to increase resistance (heavy loads).
- turn counter-clockwise to decrease resistance (lightweight loads).



WARNING:

Maximum permitted load on the tray: 3.5 Kg (without negatoscope) or 2.5 Kg (with negatoscope).

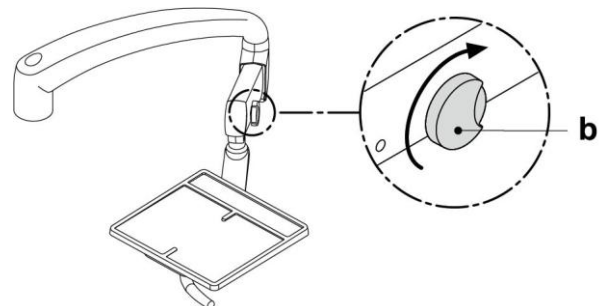

9. MAINTENANCE

Preventive maintenance

CEFLA s.c., the manufacturer of the dental units, in accordance with applicable standards IEC 60601-1 3rd Ed. - 2007, IEC 62353 and directive MDD 93/42, and subsequent changes, for medical devices underlines that the preventive maintenance checks for the dental unit specified in the Technical care manual and Maintenance and warranty handbook are to be carried out by authorised personnel at least once every 12 months.



WARNING:

The warranty is void if the equipment is serviced, repaired, altered or modified in any way by personnel who have not been duly authorised by CEFLA s.c..

Safety checks.

In accordance with standard IEC 62353, the safety checks specified in the Technical care manual and Maintenance and warranty handbook supplied with the dental unit are to be carried out at the intervals required by current local regulations. If no precise indications are given, CEFLA s.c., the manufacturer of the dental units, recommends checking them at least every 24 months at the time of installation and whenever electrical parts that are live are repaired/updated.



WARNING:

The manufacturer shall not be held liable for any personal injury or equipment damage if the precautions given above are not observed.

9.1. MAINTAINING THE INSTRUMENTS

Maintenance instructions for the instruments are enclosed with each instrument.



WARNING:

Maintenance of the instruments should be carried out with the equipment switched off.

9.2. DRAINING CONDENSATE

Perform this operation every day before starting work.



WARNING:

Before opening water unit flap, make sure to have turned equipment off.

Proceed as follows:

- open the side water unit cover (see paragraph 7.7.),
- place a container under condensate drain cock (**a**),
- loosen the cock knob,
- after the tank has been emptied, fully close the cock.

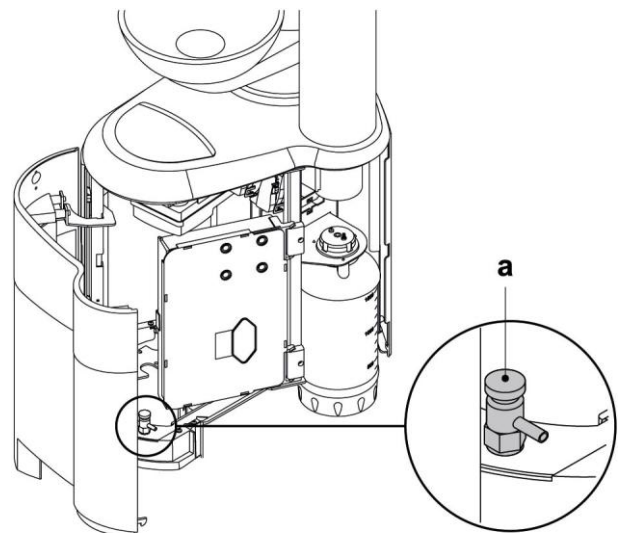

9.3. CLEANING THE SURGICAL SUCTION FILTER

This operation should be done daily at the end of work.



WARNING:
Always wear goggles and gloves to prevent contact with infected material when cleaning the suction filters.

Proceed as follows:

- one at a time, remove filter (**d**),
- clean/replace the filter (code 97461845),
- refit filter.



WARNING:
Before refitting the filter, make sure to remove any amalgam residues still present on filter seat mouth.



NOTE:
in order to prevent any dripping of liquids and secretions from the filter being removed, it is advisable to carry out the above operations with the cannula working.

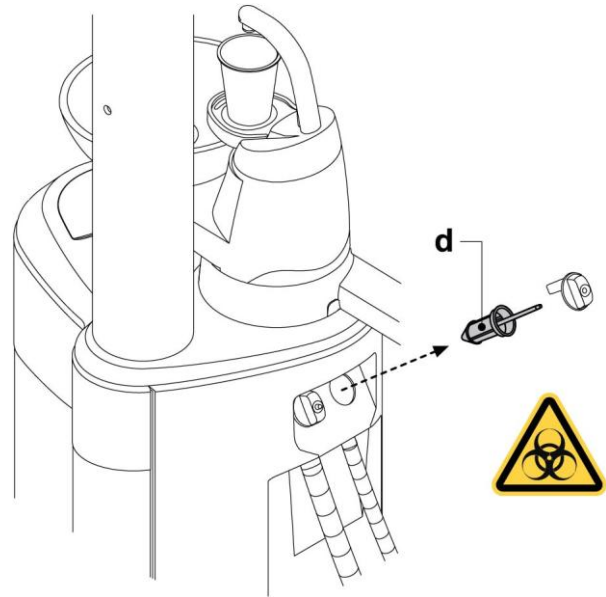

9.4. SURGICAL SUCTION

The surgical suction system must be sanitised using a product suitable for this purpose.



WARNING:
For cleaning of the suction system, it is recommended to use **STER 3 PLUS (CEFLA s.c.)** diluted in a 6% solution (equivalent to 60 ml of product in 1 litre of water).

At the end of each surgical procedure.

- Suck in about half a litre of solution prepared with the selected disinfectant with each of the suction tubes used.
- Sterilize the suction tube holder terminals in a steam autoclave up to 135°C following the instructions for use of the device.

At the end of each working day.

- Suck in 1 litre of water with each suction tube, alternating water and air (keep the suction tube alternately in and out of the water).
- Once rinsed with water, suck in approximately half a litre of the solution prepared with the selected disinfectant with each of the suction tubes used.



WARNING:
All disinfectant products must be used as specified by the manufacturer.



NOTE:
after disinfection, it is good practice to suck in air only to dry the entire suction system (5 minutes).

Once a week.

Remove the suction tube body from its hose attachment and lubricate the O-rings (**o**) using S1-Protective Lubricant for O-Rings (CEFLA s.c.).

Once a year.

Replace the suction tubes and suction tube holder terminals.

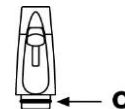
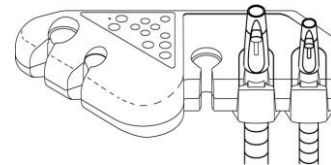

9.5. CATTANI SURGICAL SEPARATOR

At the beginning of each working day.

Insert inside filter (**d**) a tablet (**v**) of VF CONTROL PLUS (CEFLA s.c.)



WARNING:

Always wear gloves to prevent contact with infected material when carrying out this operation.

At the end of each surgical procedure.

- Suck in about half a litre of solution prepared with the selected disinfectant with each of the suction tubes used.
- Sterilize the suction tube holder terminals in a steam autoclave up to 135°C following the instructions for use of the device.

At the end of each working day.

- Suck in 1 litre of water with each suction tube, alternating water and air (keep the suction tube alternately in and out of the water).
- Once rinsed with water, suck in approximately half a litre of the solution prepared with the selected disinfectant with each of the suction tubes used.



NOTE:

after disinfection, it is good practice to suck in air only to dry the entire suction system (5 minutes).

Every 15 days.

- Clean the separator container and probes with a soft non-abrasive sponge and neutral detergent.
- Clean the drain valve for the separator's container with the device provided for this purpose.

Once a year.

- By technician: check the siphons and drains, check all the internal tubes and plastic and rubber parts subject to wear.

Before leaving the surgery for a few days.

- Start suction and run it for 20-30 minutes without sucking in any liquids. The suction unit will dry completely. As a result, salt caused by moisture and basic substances will not form. Said salt may cause fan seizure and motor blockage.

How to remove the separator's container.



WARNING:

Always wear gloves to prevent contact with infected material when carrying out the following operation.

- Open the water unit side cover.
- If installed, partially take tanks (**a**) and/or (**z**) out to release separator reservoir (**d**).



NOTE:

we recommend carrying out this operation with the tanks partially empty.

- Completely empty the separator container, pressing the timed button (**c**) located on the cover.
- If present, remove the valve (**s**) for central systems.
- Turn and raise the container (**d**) until it is detached from the drain pump (**k**).
- Detach the container (**d**) from the cover (**f**) pulling up the two side rubber bands (**e**).
- After the cleaning operations, refit the container (**d**) after lubricating the O-rings with S1-Protective Lubricant for O-Rings (CEFLA s.c.).
- Close the water unit side cover.

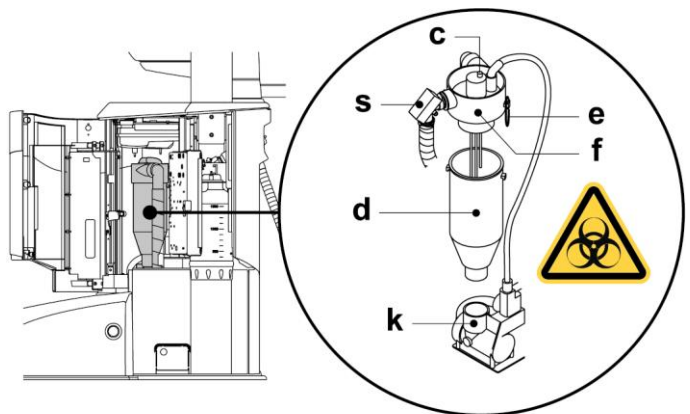
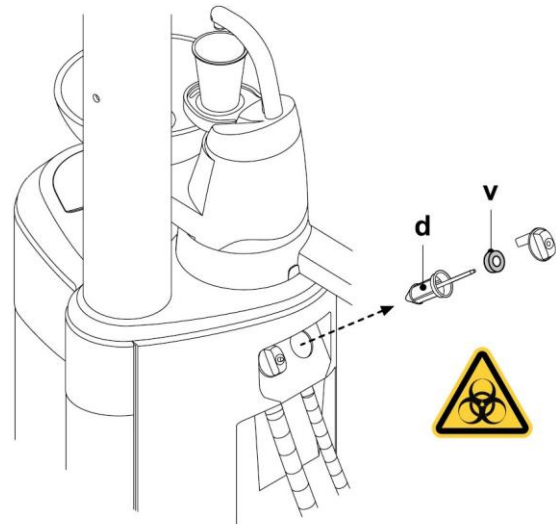

Blocked drain pump signal.

A special icon (**A**) on the TOUCH DISPLAY signals whether the drain pump located under separator reservoir is blocked.

Now you are recommended to turn equipment off and manually empty the separator reservoir.

If the icon appears again, contact the Technical Service.



9.6. CLEANING THE TURBINE RETURN AIR FILTER

Monthly check the oil container filter (**g**) present in the turbine's return air line.

If necessary, replace the filter element (code 97290014).

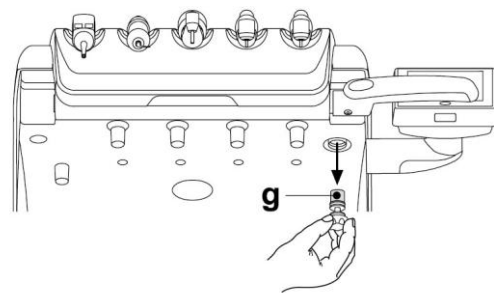

9.7. METASYS AMALGAM SEPARATOR

The maintenance instructions for the METASYS amalgam separator are enclosed with the equipment, if the equipment comes with this type of separator.

The separator control device is located in the water unit.



WARNING:

Always wear goggles and gloves to prevent contact with infected material when cleaning the separator.



WARNING:

When disposing of disposable containers full of amalgam, observe current local and national laws.

9.8. DÜRR AMALGAM SEPARATOR

The maintenance instructions for the DÜRR amalgam separator are enclosed with the equipment if the equipment comes with this type of separator.

The separator control device is located in the water unit.



WARNING:

Always wear goggles and gloves to prevent contact with infected material when cleaning the separator.



WARNING:

When disposing of disposable containers full of amalgam, observe current local and national laws.

9.9. DENTAL CHAIR

The dental chair does not need any special maintenance.

In any case, operation should be checked by ANTHOS authorised personnel once a year.

10. WARNING MESSAGES

M = Message on console display

C = Cause

R = Remedy

M: "H2O reserve, fill tank"

C: The level of fluid inside independent water supply tank has dropped below the min. level.

R: Fill the tank (see paragraph 7.2.).

M: "Put the instruments back in place"

C: During sanitation cycle setting, an extracted instrument was detected by the system.

R: Make sure that all instruments are correctly inserted in their holders and repeat cycle setting. If the error message appears again, call Technical Service.

M: "Check instruments, repeat cycle"

C: During sanitation or flushing cycle, system detected that extracted instruments have been edited.

R: Check the selected instruments and repeat the sanitation (see paragraph 7.4.) or flushing (see paragraph 7.5.) cycles.

M: "H2O2 reserve, fill tank"

C: Oxygenated water level present inside the relevant tank dropped below the min. level.

R: Fill the oxygenated water tank (see paragraph 7.4.).

M: "Open spray H2O cocks"

C: During sanitation cycle, system cannot carry out duct filling with oxygenated water.

R: Open spray water cocks and repeat the sanitation cycle (see paragraph 7.4.). If the error message appears again, call Technical Service.

M: "Extract all instruments"

C: During sanitation cycle, system detected an internal malfunction.

R: Repeat the sanitation cycle by selecting all instruments. If the error message appears again, call Technical Service.

M: "Empty the WHE system"

C: WHE system malfunction.

R: Drain the WHE inner tank and reset the system (see paragraph 5.1.1.2.3.). If the error message appears again, call Technical Service.

M: "Select the WHE system"

C: Systems attempts running a function requiring the WHE system to be enabled.

R: Enable the WHE system (see paragraph 7.3.).

M: "Check suction tubes, repeat cycle"

C: During sanitation or flushing cycle, system detected that suction tubes are not connected to their couplings.

R: Make sure that suction tubes are correctly connected and repeat the sanitation (see paragraph 7.4.) or flushing (see paragraph 7.5.) cycle. If the error message appears again, call Technical Service.

M: "Extract at least one instrument"

C: Attempt to start a sanitation cycle without having selected any instrument or cup.

R: Repeat the sanitation cycle by selecting at least one instrument or cup. If the error message appears again, call Technical Service.

M: "Instrument set"

C: The instrument on that specific board position has been automatically set with factory data.

R: If the error message appears again, call Technical Service.

M: "Put suction tubes back in place"

C: When dental unit is turned on, suction tubes are extracted.

R: Make sure that suction tubes are duly positioned inside their housings. If the error message appears again, call Technical Service.

M: "Put instrument back in place"

C: When the dental unit is turned on, an instrument is extracted.

R: Make sure that all instruments are duly positioned inside their seats. If the error message appears again, call Technical Service.

M: "Check filter suction tubes"

C: Suction tube flushing cycle malfunction.

R: Make sure that filters are clean, suction tubes are not closed and that suction unit works properly, then repeat the flushing cycle. If the error message appears again, call Technical Service.

M: "Water unit emergency activated"

C: During an automatic movement, assistant's board has met an obstacle.

R: Remove the obstacle and press again the button corresponding to the desired programme.

M: "Move dental chair down"

C: Bowl does not move due to interference with the dental chair.

R: Move dental chair down until quitting the interference area.

M: "Check light fuses"

C: Operating light does not turn on due to a lack of power.

R: Call Technical Service.

M: "Perform scheduled maintenance"

C: System requires scheduled maintenance.

R: Contact the Technical Service to programme the maintenance operation.

M: "Foot board emergency activated"

C: Dental chair has met an obstacle.

R: Press "Seat up" button and remove the obstacle.

M: "Backrest emergency activated"

C: Dental chair backrest has met an obstacle.

R: Press "Seat up" button and remove the obstacle.

M: "Move bowl"

C: The chair does not move due to interference with the bowl.

R: Move bowl until quitting the interference area.

M: "Seat emergency activated"

C: Dental chair has met an obstacle.

R: Press "Seat up" button and remove the obstacle.

M: "Delivery emergency activated"

C: The Side Delivery board has met an obstacle.

R: Press dental chair "Seat up" button and remove the obstacle.

M: "Dental chair lock, put instrument back in place"

C: Dental chair movement is requested while one instrument is extracted.

R: Put instrument back in place and repeat dental chair movement.

M: "Dental chair lock activated"

C: Dental chair movement was requested while it is in lockout condition.

R: Remove dental chair lock (see paragraph 4.).

**WARNING:**

M: "XXXX, call technical service" (where XXXX refers to a numerical code).

C: This type of message refers to a severe internal error.

R: Call Technical Service and communicate error number.

11. TECHNICAL DATA

Installation plan:	97042104
Technical manual:	97071191
Dental unit spare parts catalogue:	97023121
Dental chair spare parts catalogue:	97023121
Maximum dental unit weight:	90 Kg.
Maximum dental chair weight:	115 Kg.
Maximum dental chair load capacity:	190 Kg.
Rated voltage:	230V~ / 115V~
Nominal frequency:	50/60 Hz.
Absorbed power:	1800W (230V~) 1300W (115V~)
Air connection:	1/2 Gas.
Air supply pressure:	6-8 bar.
Air flow rate:	82 l/min.
Water connection:	1/2 Gas.
Water supply pressure:	3-5 bar.

Water delivery flow rate:	10 l/min
Water consumption:	2 l/min.
Water hardness:	< 25 °f (14 °d)
Drain connection:	ø40 mm.
Drainage flow rate:	10 l/min.
Drain duct inclination:	10 mm/m.
Suction connection:	ø40 mm.
Suction vacuum (minimum):	65 mbar.
Suction flow rate:	450 l/min.
Type-approval:	CE 0051
Electrical work in compliance with:	IEC 60364-7-710
Dental unit packaging dimensions:	1570 x 780 x 1495(h)
Dental chair packaging dimensions:	1510 x 730 x 1000(h)
Dental unit packaging weight:	155 Kg.
Dental chair packaging weight:	100 Kg.

FUSES

Identification	Value	Protection	Position
<i>Dental unit.</i> Fuse F2	T 12.5 A	230 V~: Dental unit power supply line.	Connection box.
	T 16 A	115 V~: Dental unit power supply line.	
Fuse F4	T 6.3 A	Secondary protection: Water unit.	Connection box.
Fuse F5	T 6.3 A	Secondary protection: Dental unit.	Connection box.
Fuse F6	T 6.3 A	Secondary protection: Operating light.	Connection box.
<i>Dental chair.</i> Fuse F1	T 6.3 A	230 V~: Dental chair power supply line.	Connection box.
<i>Quick-couplings.</i> Fuse	T 2 A	230 V~: Power outlet supply line.	Connection box.
<i>MONITOR power supply.</i> Fuse	T 4 A	21 V~ : MULTIMEDIA power line.	Dental chair card area.

11.1. DIMENSIONAL CHARACTERISTICS

DIMENSIONAL CHARACTERISTICS OF L9 CONTINENTAL MODEL WITH DENTIST CHAIR A 3.0 FL

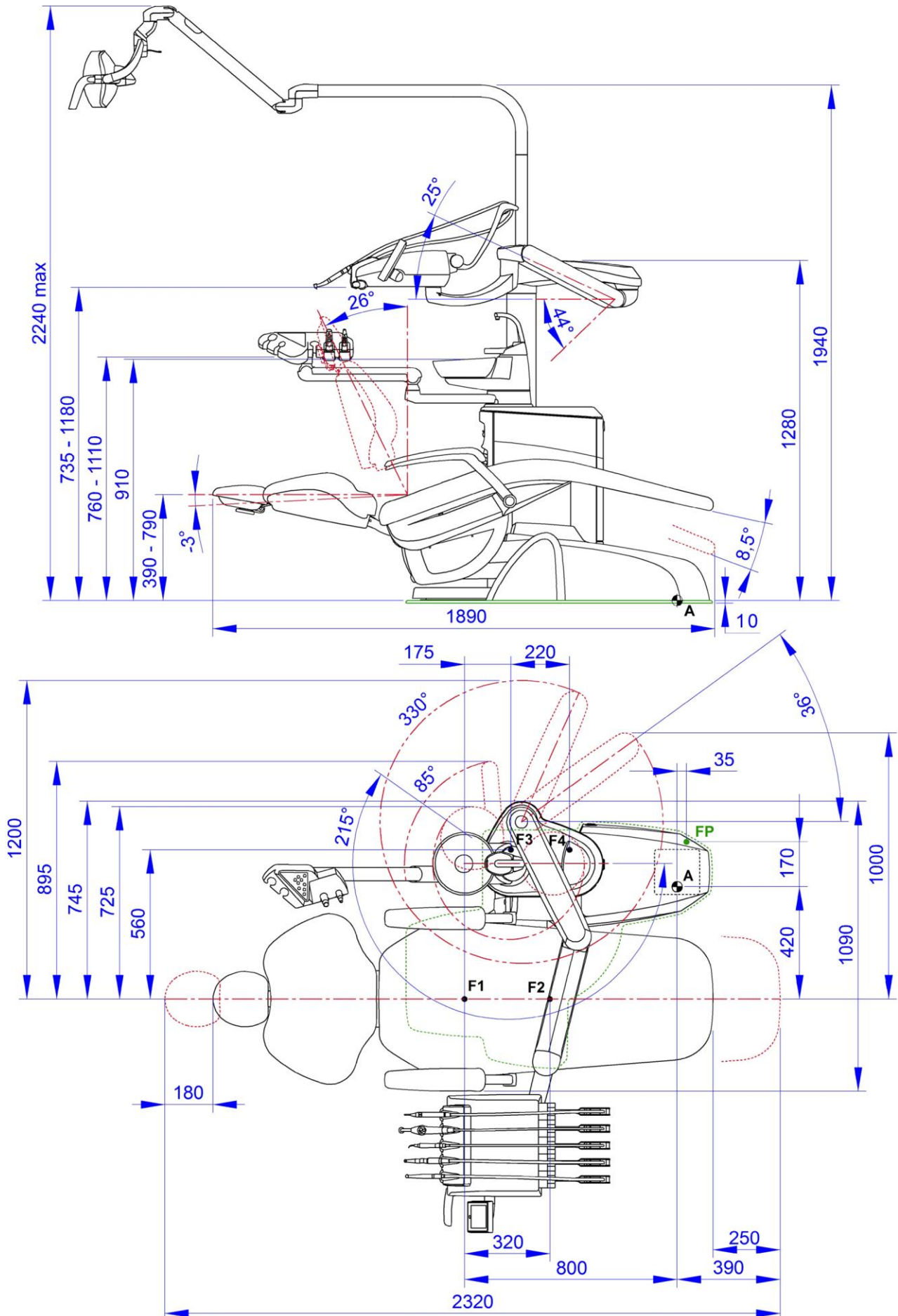

DIMENSIONAL CHARACTERISTICS OF L9 CONTINENTAL MODEL WITH DENTIST CHAIR A 3.0 ML

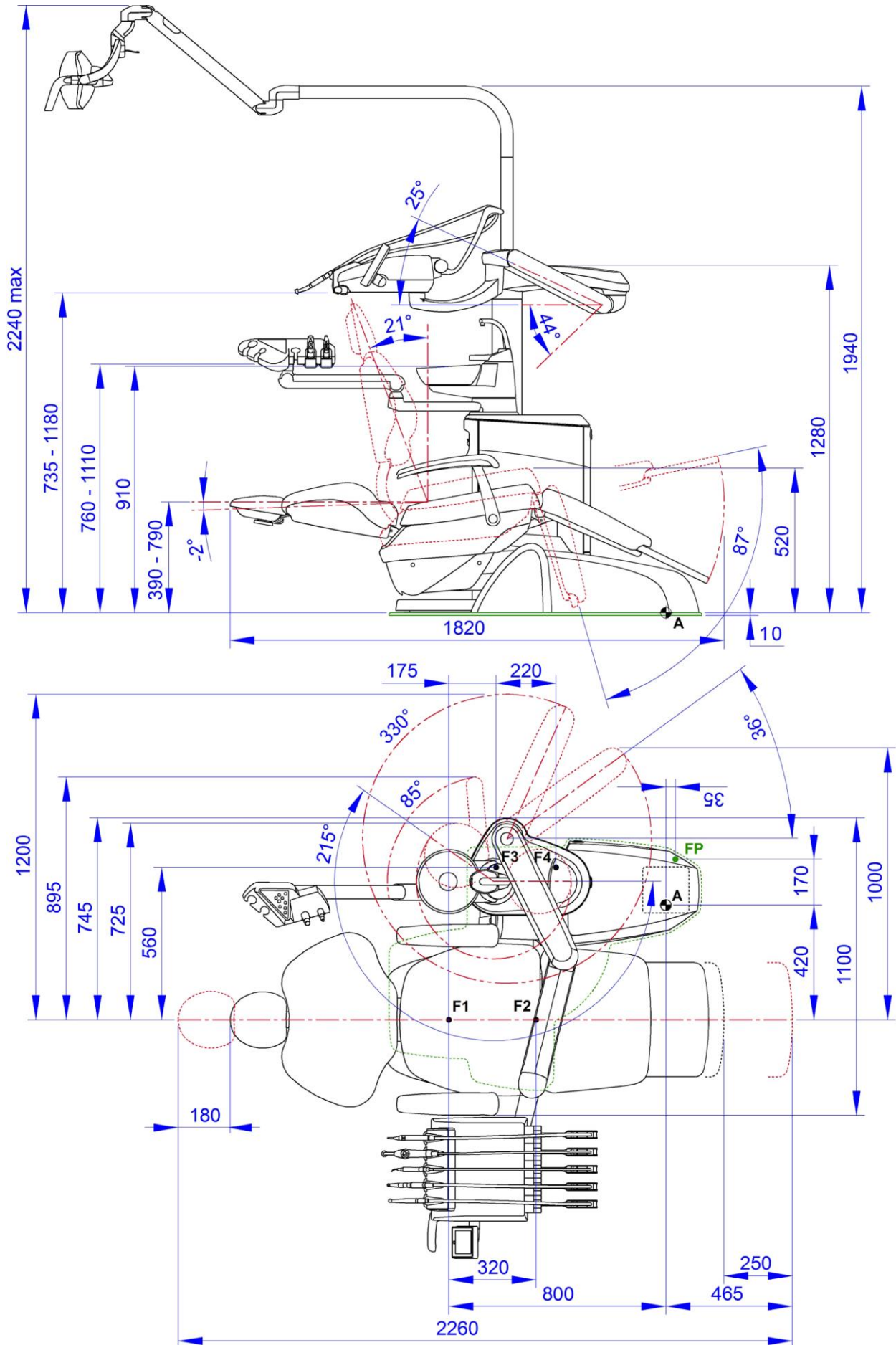

DIMENSIONAL CHARACTERISTICS OF L9 SIDE DELIVERY MODEL WITH DENTIST CHAIR A 3.0 FL

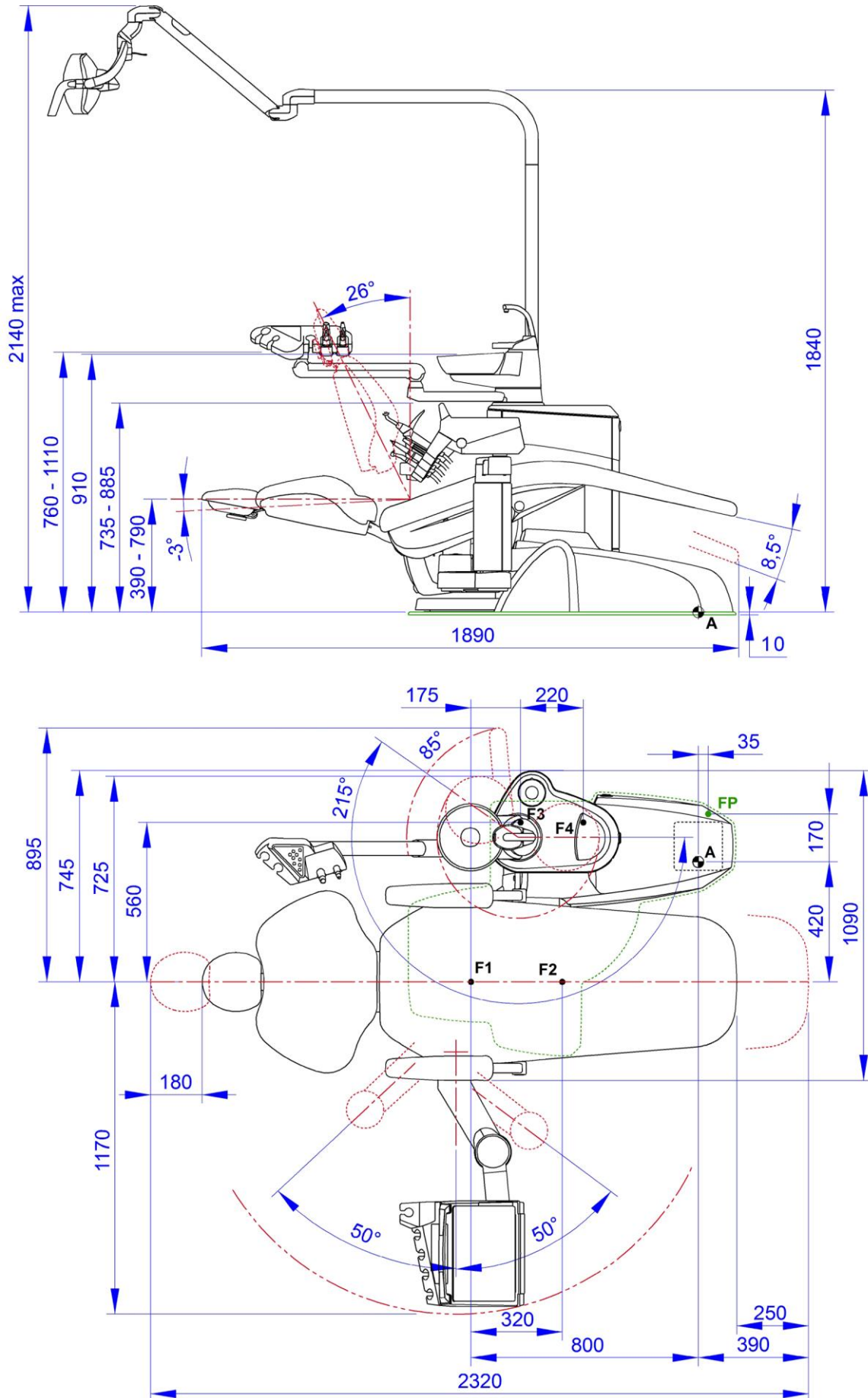

DIMENSIONAL CHARACTERISTICS OF L9 SIDE DELIVERY MODEL WITH DENTIST CHAIR A 3.0 ML

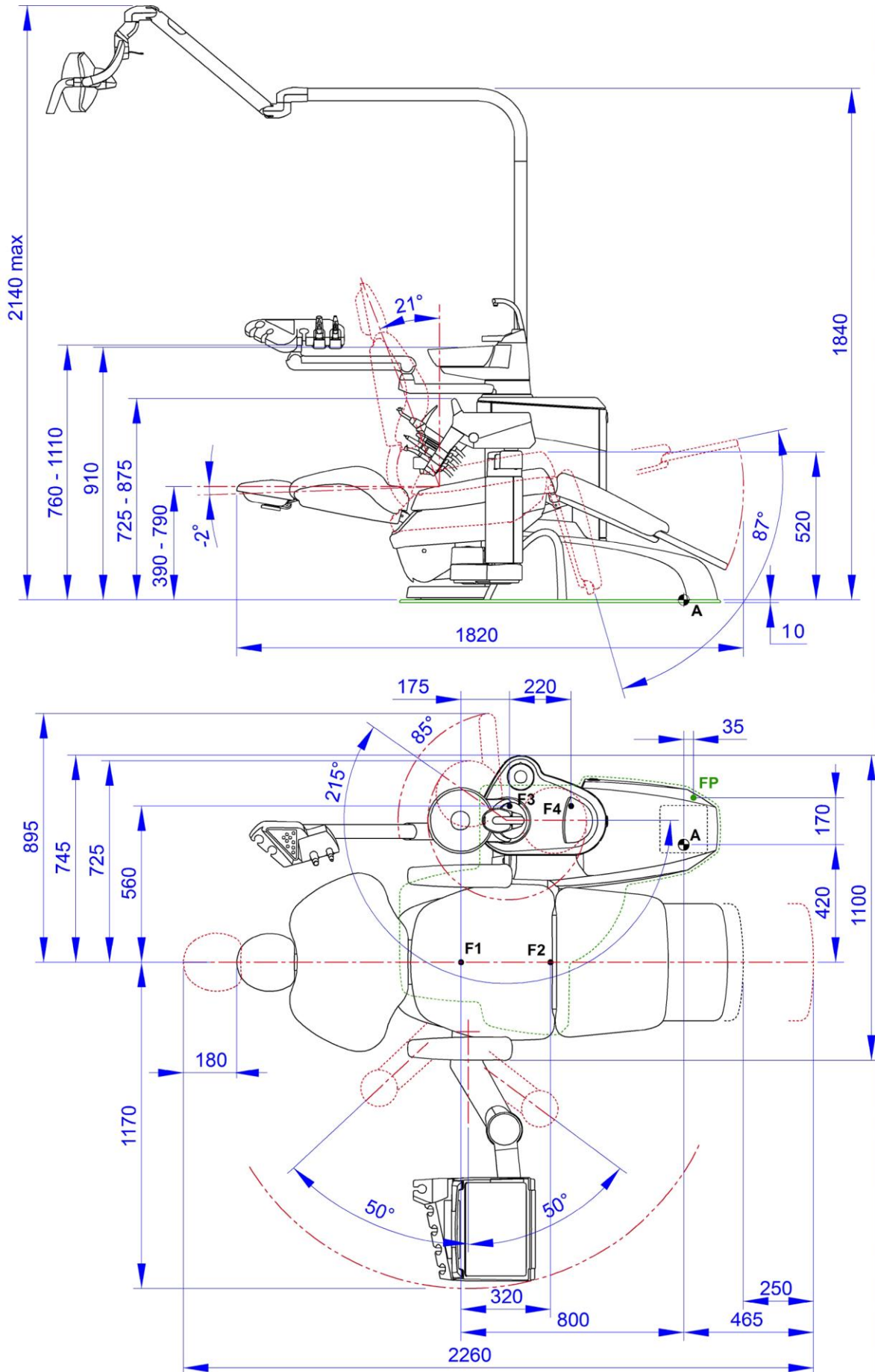

12. DENTAL UNIT OPERATING UNIT MAINTENANCE PLAN

WHEN	PART	ACTION	REFERENCE PARAGRAPH
Before starting the work day.	Drain condensate.	/	See paragraph 9.2.
	CATTANI surgical separator.	Insert inside each suction tube filter a tablet of VF CONTROL PLUS.	See paragraph 9.5.
After each treatment.	Contra-angle handpiece.	Sterilise or disinfect outside.	See documentation enclosed with handpiece.
	Turbine.	Sterilise or disinfect outside.	See paragraph 5.4.
	Micromotor.	Disinfect outside.	See paragraph 5.5.
	Scaler.	Sterilise or disinfect outside.	See paragraph 5.6.
	Syringe.	Sterilise or disinfect outside.	See paragraph 5.3.
	Curing Light.	Sterilize the fibre optics, disinfect the outside.	See paragraph 5.7.
	C-U2 camera.	Disinfect outside. Do not use acid or harsh products.	See paragraph 5.8.
	Surgical suction tubes.	Suck in about 1/2 litre of sanitising solution with each of the suction tubes. Sterilize suction tube holder terminals.	See paragraph 9.4.
When needed.	Bowl	Clean with off-the-shelf detergents formulated for ceramic materials. Do not use acid or harsh products.	See paragraph 7.1
	METASYS surgical separator.	See documents enclosed with equipment.	/
	DÜRR surgical separator.	See documents enclosed with equipment.	/
	Operating light.	See documents enclosed with equipment.	/
	Monitor on light pole.	See documents enclosed with equipment	/
	Removable instrument cords.	Clean with suitable disinfectant in compliance with manufacturer's recommendations. Do not use acid or harsh products.	See paragraph 5.
	Dental chair coated surfaces and upholstery.	Clean with suitable disinfectant in compliance with manufacturer's recommendations. Spray product on disposable soft paper. Do not use acid or harsh products.	See paragraph 1.4.
At the end of the work day.	Bowl filter.	Clean filter in running water. The content must be disposed of separately.	See paragraph 7.1.
	Surgical suction filter.	Check filter and, in case suction capacity is reduced, change it (code 97461845).	See paragraph 9.3.
	Surgical suction tubes.	Clean the filter of the saliva ejector terminal.	See paragraph 9.4.
Weekly.	CATTANI surgical separator.	Clean the separator container, drain valve and probes.	See paragraph 9.5.
	Suction tube holder terminals	Lubricate the O-ring.	See paragraph 9.4.
Monthly.	Turbine return air filter.	Check the filter and replace it if necessary (code 97290014).	See paragraph 9.6.
Yearly.	Dental chair.	Contact the technical service department for general inspection.	/

**DICHIARAZIONE DI CONFORMITÀ “CE / EU” / “CE / EU” CONFORMITY DECLARATION
DECLARATION DE CONFORMITÉ “CE / EU” / ERKLÄRUNG VON “CE / EU” ZUSTIMMUNG / DECLARACION DE CONFORMIDAD “CE / EU”
DECLARAÇÃO DE CONFORMIDADE “CE / EU” / ΔΗΛΩΣΗ ΠΙΣΤΟΤΗΤΑΣ “CE / EU” / ДЕКЛАРАЦИЯ СООТВЕТСТВИЯ “CE / EU”
DEKLARACJA ZGODNOSCI WE “CE / EU” / “CE / EU” UYGUNLUK BELGESİ**

Prodotto tipo/ Product type :

Matr./ Serial N°:

Incollare in questo spazio l'etichetta del complesso odontoiatrico o di altra apparecchiatura o indicare modello e numero di matricola
Stick the label of the dental equipment or other device into this space or write model and serial number

- I** Dichiariamo sotto la nostra esclusiva responsabilità che i prodotti ai quali questa dichiarazione si riferisce sono conformi
1) ai requisiti essenziali (Allegato I) presenti nella direttiva 93/42/CEE Dispositivi Medici (D.Lgs.46/97) e successive modifiche ed integrazioni (**dispositivo medico di Classe IIa**)
2) alla direttiva 2011/65/UE del Parlamento europeo e del Consiglio dell'8 giugno 2011, sulla restrizione dell'uso di determinate sostanze pericolose nelle apparecchiature elettriche ed elettroniche (Rohs 2)
- GB** We declare, on our sole responsibility, that the products referred to herein are in compliance with
1) the essential requirements (Annexe I) of Directive 93/42/EEC Medical devices (Leg. Decree 46/97) and subsequent amendments and integrations (**Class IIa medical device**)
2) Directive 2011/65/EU of the European Parliament and of the Council of 8 June 2011 on the restriction of the use of certain hazardous substances in electrical and electronic equipment (Rohs 2)
- F** Nous déclarons, sous notre complète responsabilité, que les produits auxquels la présente déclaration fait référence sont conformes
1) aux exigences essentielles (Annexe I) présentes dans la directive 93/42/CEE "Dispositifs médicaux" (Décr.L. 46/97) et modifications successives et intégrations (**dispositif médical de Classe IIa**)
2) à la directive 2011/65/UE du Parlement européen et du Conseil du 8 juin 2011 relative à la limitation de l'utilisation de certaines substances dangereuses dans les équipements électriques et électroniques (Rohs 2)
- D** Wir erklären hiermit in alleiniger Verantwortung, dass die Produkte, auf die sich diese Erklärung bezieht, konform sind mit
1) den grundlegenden Anforderungen (Anhang I) der Richtlinie 93/42/EWG über Medizinprodukte (Gesetzesverordnung 46/97) und nachfolgenden Änderungen und Ergänzungen (**medizinisches Gerät der Klasse IIa**)
2) der Richtlinie 2011/65/EU des Europäischen Parlaments und des Rats vom 8. Juni 2011 zur Beschränkung der Verwendung bestimmter gefährlicher Stoffe in Elektro- und Elektronikgeräten (Rohs 2)
- E** Declaramos bajo nuestra exclusiva responsabilidad que los productos a los que esta declaración se refiere, están conformes con
1) los requisitos esenciales (Anexo I) presentes en la directiva 93/42/CEE Dispositivos Médicos (D. Leg. 46/97) y sucesivas modificaciones e integraciones (**dispositivo médico de Clase IIa**)
2) la directiva 2011/65/UE del Parlamento europeo y del Consejo del día 8 de junio de 2011, sobre la restricción del uso de determinadas sustancias peligrosas en los aparatos eléctricos y electrónicos (Rohs 2)
- P** Declaramos sob a nossa exclusiva responsabilidade que os produtos aos quais esta declaração se refere estão em conformidade
1) com os requisitos essenciais (Anexo I) presentes na diretiva 93/42/CEE Dispositivos Médicos (em Itália, transposta pelo Decreto Legislativo 46/97) e posteriores alterações e aditamentos (**dispositivo médico de Classe IIa**)
2) com a diretiva 2011/65/UE do Parlamento europeu e do Conselho de 8 de junho de 2011, relativa à restrição do uso de determinadas substâncias perigosas em equipamentos elétricos e eletrónicos (Rohs 2)
- GR** Δηλώνουμε με την αποκλειστική ευθύνη μας ότι τα προϊόντα στα οποία αναφέρεται η παρούσα δήλωση είναι σύμφωνα
1) με τις βασικές απαιτήσεις (Προσάρτημα I) της οδηγίας 93/42/ΕΟΚ Ιατροτεχνολογικών Προϊόντων (Ν. Διάτ.46/97) και μεταγενέστερες τροποποιήσεις και συμπληρώσεις (**ιατροτεχνολογικό προϊόν Κατηγορίας IIa**)
2) με την οδηγία 2011/65/ΕΕ του Ευρωπαϊκού Συμβουλίου και του Συμβουλίου της 8 Ιουνίου 2011, για τον περιορισμό της χρήσης ορισμένων επικίνδυνων ουσιών σε ηλεκτρικό και ηλεκτρονικό εξοπλισμό (Rohs 2)
- PY** Под нашу исключительную ответственность заявляем, что изделия, к которым относится данная декларация, соответствуют
1) основным требованиям (Приложение I) директивы 93/42/ЕЭС Медицинские устройства (Законодательный указ № 46/97) и последующим изменениям и дополнениям (**медицинское устройство Класса IIa**)
2) директиве 2011/65/ЕС Европарламента и Совета Европы от 8 июня 2011 года по ограничению использования определенных опасных веществ в электрическом и электронном оборудовании (Rohs 2)
- PL** Oświadczamy na swoją wyłączną odpowiedzialność, że produkty objęte niniejszym oświadczeniem są zgodne:
1) z zasadniczymi wymaganiami (Załącznik I) przewidzianymi dyrektywą 93/42/EWG Wyroby Medyczne (D. z mocą ustawy 46/97) wraz z późniejszymi zmianami i uzupełnieniami (**wyrób medyczny Klasa IIa**)
2) z dyrektywą 2011/65/WE Parlamentu europejskiego i Rady z dnia 8 czerwca 2011r. w sprawie ograniczeń we wprowadzaniu do obrotu i stosowaniu w sprzęcie elektrycznym i elektronicznym określonych niebezpiecznych substancji (Rohs 2)
- TR** Bu beyannameye bahsi geçen ürünlerin aşağıda belirtilenlere uygun olduğunu kendi mühasir sorumluluğumuz altında beyan ederiz:
1) (Kanun hükmünde Kararname 46/97) Medikal Aygıtlar 93/42/CEE direktifinde mevcut (Ek 1) ana gereklilikler ve sonraki değişiklikler ve eklemlerde belirtilenler (**IIa sınıf medikal aygıt**)
2) 8 Haziran 2011 tarihli Avrupa Parlamentosu ve Konseyi'nin "Elektrikli ve elektronik cihazlarda bazı tehlikeli maddelerin kullanılmasına ilişkin kısıtlamalar" 2011/65/UE direktifi (Rohs 2)

Imola, li _____

Bussolari Paolo
Managing Director

